

Errata

This manual may contain references to HP or Hewlett-Packard. Please note that Hewlett-Packard's former test and measurement, semiconductor products and chemical analysis businesses are now part of Agilent Technologies. To reduce potential confusion, the only change to product numbers and names has been in the company name prefix: where a product number/name was HP XXXX the current name/number is now Agilent XXXX. For example, model number HP8648 is now model number Agilent 8648.

Ce manuel peut contenir des références à <<HP>> ou <<Hewlett-Packard.>> Veuillez noter que les produits de test et mesure, de semi-conducteur et d'analyse chimique qui avaient fait partie de la société Hewlett-Packard sont maintenant une partie de la société Agilent Technologies. Pour réduire la confusion potentielle, le seul changement aux noms de référence a été dans le préfixe de nom de société : là où un nom de référence était HP XXXX, le nouveau nom de référence est maintenant Agilent XXXX. Par exemple, le HP 8648 s'appelle maintenant Agilent 8648.

Diese Gebrauchsanweisung kann Bezug nehmen auf die Namen HP oder Hewlett-Packard. Bitte beachten Sie, dass ehemalige Betriebsbereiche von Hewlett-Packard wie HP-Halbleiterprodukte, HP-chemische Analysen oder HP-Test- und Messwesen nun zu der Firma Agilent Technology gehören. Um Verwirrung zu vermeiden wurde lediglich bei Produktname und - Nummer der vor laufende Firmenname geändert: Produkte mit dem Namen/Nummer HP XXXX lauten nun mehr Agilent XXXX. Z.B. das Modell HP 8648 heißt nun Agilent 8648.

Questo manuale potrebbe contenere riferimenti ad HP o Hewlett-Packard. Si noti che le attività precedentemente gestite da Hewlett-Packard nel campo di Test & Misura, Semiconduttori, ed Analisi Chimica sono ora diventate parte di Agilent Technologies. Al fine di ridurre il rischio di confusione, l'unica modifica effettuata sui numeri di prodotto e sui nomi ha riguardato il prefisso con il nome dell'azienda : dove precedentemente compariva "HP XXXX" compare ora "Agilent XXXX". Ad esempio: il modello HP8648 è ora indicato come Agilent 8648.

Este manual puede hacer referencias a HP o Hewlett Packard. Las organizaciones de Prueba y Medición (Test and Measurement), Semiconductores (Semiconductor Products) y Análisis Químico (Chemical Analysis) que pertenecían a Hewlett Packard, ahora forman parte de Agilent Technologies. Para reducir una potencial confusión, el único cambio en el número de producto y nombre, es el prefijo de la compañía: Si el producto solía ser HP XXXX, ahora pasa a ser Agilent XXXX. Por ejemplo, el modelo HP8648 es ahora Agilent 8648.

这个手册里面可能含有惠普公司的资料。请注意惠普公司以前的测试, 半导体产品, 化学分析部门现在属于安捷伦公司。为了减少可能的误解, 产品号码和名字只改变最前面的公司名字。如果一个产品的号码/名字以前是HP XXXX, 现在的号码/名字是安捷伦 XXXX。例如模型号码是惠普8648。现在是模型号码安捷伦8648。

Document Part Number E1416-90017
Printed in the UK July 1997

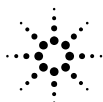

Agilent Technologies

マニュアル・チェンジ

変更

本文中の「HP (YHP)」、または「(横河)ヒューレット・パッカー株式会社」という語句を、「Agilent」、または「アジレント・テクノロジー株式会社」と変更してください。

ヒューレット・パッカー社の電子計測、半導体製品、化学分析ビジネス部門は分離独立し、アジレント・テクノロジー社となりました。

社名変更に伴うお客様の混乱を避けるため、製品番号の接頭部のみ変更しております。

(例: 旧製品名 HP 4294A は、現在 Agilent 4294A として販売いたしております。)



HP 75000 SERIES C

POWER METER HP E1416A

User's Manual

Enclosed is the User's Manual for the HP E1416A Power Meter. Insert this manual, plus any other VXIbus manuals that you have, into the binder that came with your Hewlett-Packard mainframe.

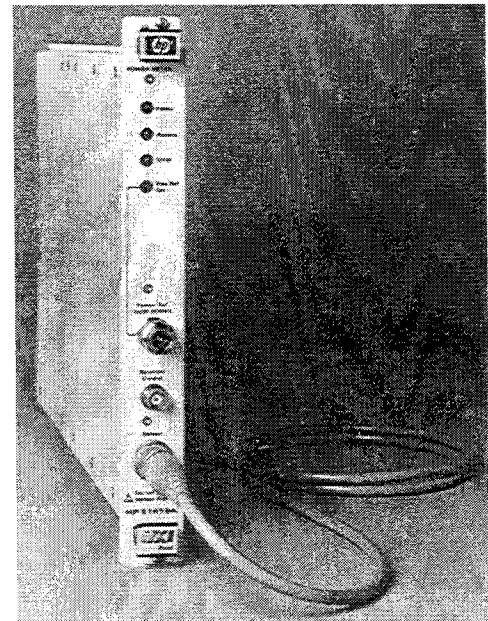

Agilent Technologies

Copyright © Hewlett-Packard Company, 1997



Manual Part Number E1416-90017

E1416-90017
E0797

Printed July 1997 Edition 3
Printed in the UK
E0797

HP E1416A Power Meter User's Manual



**HP Part No. E1416-90017
Printed in the United Kingdom**

**Third Edition
E0797**

Declaration of Conformity

DECLARATION OF CONFORMITY

according to ISO/IEC Guide 22 and EN45014

Manufacturer's Name: Hewlett-Packard Limited

Manufacturer's Address: Queensferry Microwave Division
South Queensferry
West Lothian, EH30 9TG
Scotland, United Kingdom

declares, that the product

Product Name: Power Meter
Product Number(s): HP E1416A
Product Options: This declaration covers all options of the above product

conforms to the following Product Specifications:

Safety: EN 61010 -1:1993/IEC 1010 -1: 1990+A1

EMC EN55011: 1991/CISPR11:1990, Group 1 - Class A ¹⁾
EN 50082 -1:1992

Supplementary Information:

The product herewith complies with the requirements of the Low Voltage Directive 72/23/EEC and the EEC Directive 89/336/EEC and carries the CE-marking accordingly.

1) The product was tested installed in a HP 75000 series C, HP 1400B, with all unused slots covered with single blanking plates with triple gasket.

South Queensferry, May 26, 1997



R.M. Evans/ Quality Manager

European Contact:

Your local Hewlett-Packard Sales and Service Office or Hewlett-Packard GmbH, Department ZQ/Standards Europe
Herrenberger Strasse 130, D-7030 Boblingen (FAX: +49-7031-143143)

Warranty

This Hewlett-Packard product is warranted against defects in materials and workmanship for a period of three years from date of shipment. Duration and conditions of warranty for this product may be superceded when the product is integrated into (becomes a part of) other HP products. During the warranty period, Hewlett-Packard Company will, at its option, either repair or replace products which prove to be defective.

For warranty service or repair, this product must be returned to a service facility designated by Hewlett-Packard (HP). Buyer shall prepay shipping charges to HP and HP shall pay shipping charges to return the product to Buyer. However, Buyer shall pay all shipping charges, duties, and taxes for products returned to HP from another country.

HP warrants that its software and firmware designated by HP for use with an instrument will execute its programming instructions when properly installed on that instrument. HP does not warrant that the operation of the instrument, or software, or firmware will be uninterrupted or error free.

Limitation of Warranty

The foregoing warranty shall not apply to defects resulting from improper or inadequate maintenance by Buyer, Buyer-supplied products or interfacing, unauthorized modification or misuse, operation outside of the environmental specifications for the product, or improper site preparation and maintenance

NO OTHER WARRANTY IS EXPRESSED OR IMPLIED. HP SPECIFICALLY DISCLAIMS THE IMPLIED WARRANTIES OF MERCHANTABILITY AND FITNESS FOR A PARTICULAR PURPOSE.

Exclusive Remedies

THE REMEDIES PROVIDED HEREIN ARE BUYER'S SOLE AND EXCLUSIVE REMEDIES. HEWLETT-PACKARD SHALL NOT BE LIABLE FOR ANY DIRECT, INDIRECT, SPECIAL, INCIDENTAL, OR CONSEQUENTIAL DAMAGES WHETHER BASED ON CONTRACT, TORT, OR ANY OTHER LEGAL THEORY.

Certification

Hewlett-Packard Company certifies that this product met its published specifications at the time of shipment from the factory. Hewlett-Packard further certifies that its calibration measurements are traceable to the United States National Institute of Standards, to the extent allowed by the Institute's calibration facility and to the calibration facilities of other International Standards Organization members!

Assistance

Product maintenance agreements and other customer assistance agreements are available for Hewlett-Packard products. For any assistance, contact your Hewlett-Packard Sales and Service Office. Addresses are provided at the back of this manual.

Notice

The information contained in this document is subject to change without notice.

Hewlett-Packard shall not be liable for errors contained herein or for incidental or consequential damages in connection with the furnishing, performance or use of this material.

This document contains proprietary information which is protected by copyright. All rights are reserved. No part of this document may be photocopied or reproduced without the prior written consent of the manufacturer, Hewlett-Packard Ltd.

Restricted Rights Legend

Use, duplication, or disclosure by the Government is subject to restrictions as set forth in subdivision (b)(3)(ii) of the Rights in Technical Data and Computer Software clause at 52.227-7013. Hewlett-Packard Company; 3000 Hanover Street; Palo Alto, California 94304.

Statement of Compliance

This instrument has been designed and tested in accordance with IEC Publication 1010-1 + A1:1992 Safety requirements for Electrical Equipment for Measurement, Control and Laboratory Use, and has been supplied in a safe condition. The instruction documentation contains information and warnings which must be followed by the user to ensure safe operation and to maintain the instrument in a safe condition.

Electromagnetic Compatibility (EMC) Information

This product has been designed to meet the protection requirements of the European Communities Electromagnetic Compatibility (EMC) directive 89/336/EEC. In order to preserve the EMC performance of the product, any cable which becomes worn or damaged must be replaced with the same type and specification.

Printing History

The printing history shown below lists all Editions and Updates of this manual and the printing date(s). The first printing of the manual is edition 1.

The edition number increments by one whenever the manual is revised. Updates which are issued between Editions, contain replacement pages to correct the current Edition of the manual. Updates are numbered sequentially starting with Update 1. When a new Edition is created, it contains all the Update information for the previous edition. Each new edition or update also includes a revised copy of this printing history page. Many product updates or revisions do not require manual changes and, conversely, manual corrections may be done without accompanying product changes. Therefore, do not expect a one-to-one correspondence between product updates and manual updates.

Printing History

Edition	Date	Part Number	CODE
Edition 1	April 1990	E1416-90001	E0490
Update 1	Sept 1990		
Edition 2	Oct 1996	E1416-90015	E1096
Edition 3	July 1997	E1416-90017	E0797

Safety Information

The following general safety precautions must be observed during all phases of operation, service, and repair of this instrument. Failure to comply with these precautions or with specific warnings elsewhere in this manual violates safety standards of design, manufacture, and intended use of the instrument. Hewlett-Packard Company assumes no liability for the customer's failure to comply with these requirements.

This is a Safety Class I instrument (provided with a protective earthing ground, incorporated in the powercord). The mains plug shall only be inserted in a socket outlet provided with a protective earth contact. Any interruption of the protective conductor inside or outside of the instrument is likely to make the instrument dangerous. Intentional interruption is prohibited.

General

DO NOT operate the product in an explosive atmosphere or in the presence of flammable gasses or fumes.

DO NOT use repaired fuses or short-circuited fuseholders: For continued protection against fire, replace the line fuse(s) only with fuse(s) of the same voltage and current rating and type.

DO NOT perform procedures involving cover or shield removal unless you are qualified to do so: Operating personnel must not remove equipment covers or shields. Procedures involving the removal of covers and shields are for use by service-trained personnel only.









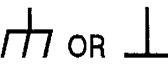

DO NOT service or adjust alone: Under certain conditions, dangerous voltages may exist even with the equipment switched off. To avoid dangerous electrical shock, service personnel must not attempt internal service or adjustment unless another person, capable of rendering first aid and resuscitation, is present.

DO NOT operate damaged equipment: Whenever it is possible that the safety protection features built into this product have been impaired, either through physical damage, excessive moisture, or any other reason, REMOVE POWER and do not use the product until safe operation can be verified by service-trained personnel. If necessary, return the product to a Hewlett-Packard Sales and Service Office for service and repair to ensure the safety features are maintained.

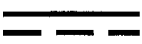
DO NOT substitute parts or modify equipment: Because of the danger of introducing additional hazards, do not install substitute parts or perform any unauthorized modification to the product. Return the product to a Hewlett-Packard Sales and Service Office for service and repair to ensure the safety features are maintained.

Safety Symbols

The following symbols on the instrument and in the manual indicate precautions which must be taken to maintain safe operation of the instrument.

Safety Symbols	
	The Instruction Documentation Symbol. The product is marked with this symbol when it is necessary for the user to refer to the instructions in the supplied documentation.
	Indicates the field wiring terminal that must be connected to earth ground before operating the equipment - protects against electrical shock in case of fault.
	Frame or chassis ground terminal - typically connects to the equipment's metal frame.
	Alternating current (AC)
	Direct current (DC)
	Indicates hazardous voltages
WARNING	Warning denotes a hazard. It calls attention to a procedure, which if not correctly performed or adhered to could result in injury or loss of life. Do not proceed beyond a warning note until the indicated conditions are fully understood and met.
CAUTION	Caution denotes a hazard. It calls attention to a procedure, which if not correctly performed or adhered to could result in damage to or destruction of the instrument. Do not proceed beyond a warning note until the indicated conditions are fully understood and met.
	The CE mark shows that the product complies with all relevant European legal Directives accompanied by a year, it's when the design was proven).
	This is a symbol of an Industrial Scientific and Medical Group 1 Class A product.
	The CSA mark is a registered trademark of the Canadian Standards Association.
 EN 60825 1991	Indicates that a laser is fitted. The user must refer to the manual for specific Warning or Caution information to avoid personal injury or damage to the product.

HP 75000 Series C Documentation

Suggested Sequence for Using the Manuals

1. **E1405A Command Module User's Manual.** Contains information on the logical addressing conventions used to create instruments that are programmed using the Test and Measurement System Language (TMSL). This manual also describes the command module's resource manager functionality and how to implement user- defined configurations. Also included is HP-IB programming information.
2. **Plug-in Module User's Manuals.** Contain programming and configuration information for the plug-in modules. These manuals contain examples for the most commonly used functions and give a complete TMSL command reference for the module.

Related Documents

Beginners Guide to TMSL. Explains the fundamentals of programming instruments using the Test and Measurement System Language (TMSL). We recommend this guide to anyone who is programming with TMSL for the first time. Hewlett-Packard part number H2325-90001.

Tutorial Description of the Hewlett-Packard Interface Bus. Describes the technical fundamentals of the Hewlett-Packard Bus (HP-IB). This document also includes general information on IEEE 488.2 Common Commands. We recommend this document to anyone who is programming with IEEE 488.2 for the first time. Hewlett-Packard part number 5952-0156.

IEEE Standard 488.2-1987, IEEE Standard Codes, Formats, Protocols, and Common Commands. Describes the underlying formats and data types used in TMSL and defines common commands. You will find this document useful if you need to know the precise definition of certain message formats, data types or common commands. Available from: The Institute of Electrical and Electronic Engineers, Inc.; 345 East 47th Street; New York, NY 10017; USA.

VXibus System Specifications. Hewlett-Packard part number E1400-90006.

The VMEbus Specification. Available from: VMEbus International Trade Association; 10229 N. Scottsdale Road, AZ 85253; USA.

About This Manual

Manual Content	This manual contains information for the HP E1416A VXI Power Meter.
Chapter 1: Introduction	This Chapter introduces you to the Power Meter. It also includes an introduction to power measurements.
Chapter 2: Getting Started	This chapter introduces you to using the power Meter. It includes sample programs to check that the Power Meter is installed correctly, to make a power measurement and to make a relative power measurement.
Chapter 3: Understanding the Power Meter	This chapter provides information to allow you to choose the best Power Meter setting for your application.
Chapter 4: Command Reference	This chapter contains a detailed description of each Power Meter command. Included is information on the choice of settings and examples showing the context in which each command is used.
Chapter 5: Configuring the Power Meter	This chapter contains information about preparing the Power Meter for use.
Appendix A: Specifications	This appendix contains the specifications for the Powe Meter.
Appendix B: Performance Tests	This appendix contains tests that allow you to confirm that the Power Meter is operating within specification.
Appendix C: Error Messages	This appendix lists the error messages associated with the Power Meter and their possible causes.

Contents

1. Introduction	
About This Chapter	1-1
Power Meter Overview	1-1
Power Measurements - an introduction	1-2
2. Getting Started	
About This Chapter	2-1
Front Panel Overview	2-2
Programming Language	2-4
Program Notes	2-4
Introduction to Operation	2-5
Power Meter Self-Test	2-5
Making a Power Measurement	2-5
Measurement Setup	2-6
Program	2-6
Program Description	2-7
Making a Relative Power Measurement	2-10
Measurement Setup	2-10
Program	2-10
Program Description	2-11
3. Understanding the Power Meter	
About This Chapter	3-1
Calibrating the Power Meter	3-2
Setting the Reference Calibration Factor	3-2
Examples	3-2
Querying the Reference Calibration Factor	3-2
Zeroing	3-3
When to Zero?	3-3
Calibration	3-3
Calibration Sequence	3-3
Using MEASure and CONFigure	3-4
Using MEASure	3-4
Using CONFigure	3-4
Making Measurements with CONFigure	3-5
Using Data Tables	3-6
Overview	3-6
To Create and Edit Tables	3-8
Procedure	3-8
Naming Data Tables	3-10
To Review Table Data.	3-11
To Modify Data	3-12

To Transfer a Table	3-12
To Enable the Data Table System.	3-12
Making the Measurement	3-13
Setting the Range, Resolution and Filter	3-14
Range	3-14
Setting the Range	3-14
Autoranging	3-15
Resolution	3-16
Filter	3-17
Auto Filter Mode	3-17
Filter Length	3-17
Loss and Gain	3-18
Comments	3-18
Limits Checking	3-19
Checking For Limit Failures	3-20
Using CALCulate	3-20
Using STATus	3-20
Measuring Pulsed Signals	3-22
Making the Measurement	3-22
Comments	3-23
Using the Power Meter with the HP 11722A Power	
Sensor	3-24
Controlling the Power Sensor	3-24
INPut[:STATe]	3-24
CONFigure, MEASure, [:SENSe]:FUNCTion	3-24
Triggering the Power Meter	3-26
The Idle State	3-26
The Initiate State	3-26
The Event Detection State	3-27
Querying the Trigger Source	3-27
Trigger Delay	3-27
Status Reporting	3-28
General Status Register Model	3-28
Condition Register	3-29
Transition Filter	3-29
Event Register	3-29
Enable Register	3-29
An Example Sequence	3-29
The Status Register	3-31
Reading the Status Register	3-32
Standard Event Status Register	3-33
Enabling Standard Event Status Bits	3-34
Clearing Status	3-34
Interrupting Your Program	3-34
Example	3-35
Example 2	3-36
Using the Operation Complete Commands	3-37
Examples	3-37
Saving and Recalling Power Meter Configurations	3-39
How to Save and Recall a Configuration	3-39
Example Program	3-39

4. Command Reference	
About This Chapter	4-1
Command Types	4-1
Common Command Format	4-1
TMSL Command Format	4-1
Command Separator	4-2
Abbreviated Commands	4-2
Implied Commands	4-2
Parameters	4-2
Linking Commands	4-3
Responses to TMSL Numeric Query Commands	4-3
TMSL Command Reference	4-4
ABORt	4-6
Subsystem Syntax	4-6
Comments	4-6
Example	4-6
AVERage	4-7
Subsystem Syntax	4-7
AVER:STAT	4-7
AVER:COUN	4-7
Comments	4-7
AVER:COUN?	4-8
AVER:COUN:AUTO	4-8
Comments	4-8
AVER:COUN:AUTO?	4-9
AVER:TYPE	4-9
AVER:TCON?	4-10
Comments	4-10
CALCulate	4-11
Subsystem Syntax	4-12
CALC:LIM:STAT	4-12
Parameters	4-12
Comments	4-13
Example	4-13
CALC:LIM:STAT?	4-13
CALC:LIM:UPP[:DATA]	4-13
Parameters	4-13
Comments	4-13
Example	4-13
CALC:LIM:UPP[:DATA]?	4-14
CALC:LIM:UPP:POIN?	4-14
CALC:LIM:UPP:STAT	4-14
Parameters	4-14
Comments	4-14
Example	4-14
CALC:LIM:UPP:STAT?	4-15
CALC:LIM:LOW[:DATA]	4-15
Parameters	4-15
Comments	4-15
Example	4-15
CALC:LIM:LOW[:DATA]?	4-16

CALC:LIM:LOW:POIN?	4-16
CALC:LIM:LOW:STAT	4-16
Parameters	4-16
Comments	4-16
Example	4-16
CALC:LIM:LOW:STAT?	4-17
CALC:LIM:FAIL?	4-17
CALC:LIM:FCO?	4-17
Comments	4-17
Example	4-17
CALC:LIM:REP[:DATA]?	4-18
Comments	4-18
CALC:LIM:REP:POIN?	4-18
Comments	4-18
CALC:LIM:CLE:AUTO	4-18
Comments	4-19
CALC:LIM:CLE:AUTO?	4-19
CALC:LIM:CLE:IMM	4-19
CALC:LIM:INT	4-19
CALC:CLIM:FAIL?	4-19
CALC:CLIM:FLIM[:DATA]?	4-20
CALC:CLIM:FLIM:POIN?	4-20
CALibration	4-21
Subsystem Syntax	4-21
CAL[:ALL]?	4-22
Comments	4-22
Example	4-22
Related Commands	4-22
CAL[:ALL]	4-23
CAL:AUTO ONCE	4-23
Comments	4-23
Example	4-23
CAL:AUTO?	4-23
Example	4-23
CAL:ZERO:AUTO ONCE	4-24
Comments	4-24
Example	4-24
Related Commands	4-24
CAL:ZERO:AUTO?	4-24
Example	4-24
CAL:CSET[:SEL]	4-25
Comments	4-25
Example	4-25
Related Commands	4-25
CAL:CSET[:SEL]?	4-25
Comments	4-25
Example	4-26
Related Commands	4-26
CAL:CSET:STAT	4-26
Parameters	4-26
Comments	4-26

Example	4-26
Related Commands	4-26
CAL:CSET:STAT?	4-27
Comments	4-27
Example	4-27
Related Commands	4-27
CAL:CSET:INT	4-27
CAL:CFAC[:POW]	4-27
Parameters	4-27
Comments	4-28
Example	4-28
CAL:CFAC[:POW]?	4-28
Comments	4-28
Example	4-28
CAL:RCF[:POW]	4-29
Parameters	4-29
Comments	4-29
Example	4-29
CAL:RCF[:POW]?	4-29
Comments	4-29
Example	4-30
CONF	4-31
Subsystem Syntax	4-31
CONF:POW:AC	4-31
Parameters	4-31
Comments	4-32
Example	4-33
CONF?	4-33
Comments	4-33
Example	4-34
FETC[:POW:AC]?	4-35
Subsystem Syntax	4-35
Comments	4-35
Example	4-35
Related Commands	4-35
INITiate	4-36
Subsystem Syntax	4-36
INIT[:IMM]	4-36
Comments	4-36
Example	4-36
INIT:CONT	4-37
Parameters	4-37
Comments	4-37
Example	4-37
INIT:CONT?	4-38
INPut	4-39
Subsystem Syntax	4-39
INP[:STAT]	4-39
Parameters	4-39
Comments	4-39
Example	4-39

INP[:STAT]?	4-40
Example	4-40
MEAS:POW:AC	4-41
Subsystem Syntax	4-41
Parameters	4-41
Comments	4-42
Example	4-43
MEMory	4-44
Subsystem Syntax	4-45
MEM:CAT[:ALL]?	4-46
Comments	4-46
Example	4-46
Related Commands	4-46
MEM:CAT:TABL?	4-47
MEM:DEF[:TABL][:NAME]	4-47
Comments	4-47
Example	4-48
MEM:DEL[:TABL][:NAME]	4-48
Example	4-48
MEM:DEL:ALL	4-48
Comments	4-48
Example	4-49
MEM:PROT[:STAT]	4-49
Parameters	4-49
Comments	4-49
Example	4-49
MEM:PROT[:STAT]?	4-49
Example	4-49
MEM[:TABL]:FREQ	4-50
Parameters	4-50
Comments	4-50
Example	4-50
MEM[:TABL]:FREQ?	4-51
Comments	4-51
Example	4-51
MEM[:TABL]:FREQ:POIN?	4-51
Example	4-51
MEM[:TABL]:CFAC[:POW]	4-52
Comments	4-52
Example	4-52
MEM[:TABL]:CFAC[:POW]?	4-52
Comments	4-52
Example	4-53
MEM[:TABL]:CFAC:POIN?	4-53
Example	4-53
MEM[:TABL]:RCF[:POW]	4-53
Comments	4-54
Example	4-54
MEM[:TABL]:RCF[:POW]?	4-54
Example	4-54
MEM[:TABL]:SEL[:NAME]	4-55

Comments	4-55
Example	4-55
MEM[:TABL]:SEL[:NAME]?	4-55
Example	4-55
OUTPut	4-56
Subsystem Syntax	4-56
OUTP:ROSC[:STAT]	4-56
Parameters	4-56
Comments	4-56
Example	4-56
OUTP:ROSC[:STAT]?	4-56
Example	4-56
READ[:POW:AC]?	4-57
Subsystem Syntax	4-57
Comments	4-57
Example	4-57
Related Commands	4-57
[SENSe]	4-58
Subsystem Syntax	4-59
POW:RANG[:UPP]	4-60
Parameters	4-60
Comments	4-60
Example	4-60
POW:RANG[:UPP]?	4-61
Comments	4-61
Example	4-61
POW:RANG:LOW	4-61
Parameters	4-61
Comments	4-61
Example	4-62
POW:RANG:LOW?	4-62
Comments	4-62
Example	4-62
POW:RANG:AUTO	4-63
Parameters	4-63
Comments	4-63
POW:RANG:AUTO?	4-63
POW:RES	4-63
Parameters	4-63
Comments	4-64
Example	4-64
POW:RES?	4-65
Comments	4-65
Example	4-65
POW:REF	4-65
Parameters	4-65
Comments	4-65
Example	4-66
POW:REF?	4-66
Example	4-66
POW:REF:STAT	4-66

Parameters	4-66
Comments	4-66
Example	4-67
POW:REF:STAT?	4-67
CORR[:STAT]	4-67
Parameters	4-67
Comments	4-67
Example	4-67
CORR:STAT?	4-68
CORR:LOSS:STAT	4-68
Parameters	4-68
Comments	4-68
Example	4-68
CORR:LOSS:STAT?	4-68
CORR:LOSS[:INP][:MAG]	4-69
Parameters	4-69
Comments	4-69
Example	4-69
CORR:LOSS[:INP][:MAGN]?	4-69
CORR:GAIN:STAT	4-70
Parameters	4-70
Comments	4-70
Example	4-70
CORR:GAIN:STAT?	4-70
CORR:GAIN[:INP][:MAG]	4-70
Parameters	4-71
Comments	4-71
Example	4-71
CORR:GAIN[:INP][:MAGN]?	4-71
CORR:DCYC:STAT	4-72
Parameters	4-72
Comments	4-72
Example	4-72
CORR:DCYC:STAT?	4-72
CORR:DCYC[:INP][:MAGN]	4-72
Parameters	4-73
Comments	4-73
Example	4-73
CORR:DCYC[:INP][:MAGN]?	4-73
FUNC	4-74
FUNC:POW:AC	4-74
FREQ[:CW[:FIX]	4-74
Parameters	4-74
Comments	4-74
Example	4-75
FREQ?	4-75
STATus	4-76
Subsystem Syntax	4-76
STAT:OPER[:EVEN]?	4-77
STAT:OPER:COND?	4-77
STAT:OPER:ENAB	4-79

STAT:OPER:ENAB?	4-79
STAT:OPER:NTR	4-79
STAT:OPER:NTR?	4-79
STAT:OPER:PTR	4-79
STAT:OPER:PTR?	4-80
STAT:QUES[:EVEN]?	4-80
STAT:QUES:COND?	4-80
STAT:QUES:ENAB	4-82
STAT:QUES:ENAB?	4-82
STAT:QUES:NTR	4-82
STAT:QUES:NTR?	4-82
STAT:QUES:PTR	4-83
STAT:QUES:PTR?	4-83
STAT:PRES	4-83
SYSTEM	4-84
Subsystem Syntax	4-84
SYST:ERR?	4-84
Comments	4-84
Example	4-84
SYST:PRES	4-85
SYST:VERS?	4-87
TRIGger	4-88
Subsystem Syntax	4-88
TRIG[:IMM]	4-88
Comments	4-88
Example	4-88
Related Commands	4-89
TRIG:SOUR	4-89
Parameters	4-89
Comments	4-89
Example	4-90
Related Commands	4-90
TRIG:SOUR?	4-90
Example	4-90
TRIG:DEL:AUTO	4-90
Parameters	4-90
Comments	4-91
Example	4-91
TRIG:DEL:AUTO?	4-91
Unit	4-92
Subsystem Syntax	4-92
UNIT:POW	4-92
Comments	4-92
Example	4-92
UNIT:POW?	4-92
IEEE 448.2 Common Command Reference	4-93

5. Configuring the Power Meter	
About This Chapter	5-1
General Information	5-1
Initial Inspection	5-2
Specifications	5-3
In Case of Trouble	5-3
Setting the Power Meter's Address	5-3
The Logical Address Switch	5-3
Mating Connectors	5-4
Recorder Output	5-4
Power Ref	5-4
Sensor	5-4
A. Specifications	
Specifications vs. Characteristics	A-1
Specifications	A-1
Characteristics	A-1
Additional Information	A-4
B. Performance Tests	
Functional Verification	B-1
Operational Verification	B-1
Performance Tests	B-2
Equipment Required	B-2
Program Notes	B-3
Power-up Test	B-3
Analogue Functional Check	B-4
Zero Carryover Test	B-5
Specification	B-5
Description	B-5
Equipment	B-5
Procedure	B-5
Instrument Accuracy Test	B-7
Specification	B-7
Description	B-7
Equipment	B-7
Procedure	B-7
Power Reference Level Test	B-9
Specification	B-9
Description	B-9
Equipment	B-10
Procedure	B-10
VXLFUNC	B-13
VXLZERO	B-15
VXLACCU Part 1	B-18
VXLACCU Part 2	B-20
If Something Goes Wrong	B-24
Zero Carryover Test SetupB-1	B-5
Instrument Accuracy Test SetupB-2	B-7
Pin 1 on Thermistor MountB-3	B-10
Power Reference Level Test SetupB-4	B-10

Power-up TroubleshootingB-1	B-4
Hewlett-Packard Sales and Service OfficesB-2	B-25
C. Error Messages	
Using This Appendix	C-1
Overview	C-1
How To Read Errors	C-1
Error Numbers	C-2
Error Message FormatC-1	C-1
Error MessagesC-1	C-4
 Index	

Figures

2-1. Power Meter Front Panel	2-2
2-2. Relative Power Measurement Application	2-10
3-1. Power Sensor Data Table System	3-7
3-2. HP 8482A Decade Ranges	3-14
3-3. Limits Checking Application	3-19
3-4. Limits Checking Results	3-19
3-5. Pulsed Signal	3-22
3-6. Using the HP 11722A Power Sensor	3-24
3-7. Trigger System	3-26
3-8. Generalized Status Register Model	3-28
3-9. Typical Status Register Bit Changes	3-30
3-10. Status Structure	3-31
4-1. TMSL Command Index	4-5
4-2. CALCulate Subsystem	4-11
4-3. CALibration Subsystem	4-21
4-4. Using the HP 11722A Power Sensor	4-39
4-5. MEMory Subsystem	4-44
4-6. SENSE subsystem	4-58
5-1. Power Meter Logical Address Switch Settings	5-3
B-1. Zero Carryover Test Setup	B-5
B-2. Instrument Accuracy Test Setup	B-7
B-3. Pin 1 on Thermistor Mount	B-10
B-4. Power Reference Level Test Setup	B-10

Tables

1-1. Power Meter Main Features	1-1
1-2. Power Meter Abbreviated Specifications	1-2
2-1. Power Meter Reset (*RST) Configuration	2-8
3-1. Status Register	3-32
3-2. Standard Event Status Register	3-33
4-1.	4-83
4-2. *RST and SYSTEM:PRESet Conditions	4-86
4-3. IEEE 488.2 Command Reference	4-93
5-1. Power Meter Sensor Cables	5-2
A-1. Specifications	A-2
A-2. Characteristics	A-3
B-1. Power-up Troubleshooting	B-4

Introduction

About This Chapter

This chapter introduces you to the C-size HP E1416A VXI Power Meter. The main sections of the chapter are:

- Power Meter Overview 1-1
- Power Measurements - an introduction 1-2

Note



This manual is to be used with the HP E1416A VXI Power Meter installed in the HP 75000 Series C mainframe or other compatible mainframes which meet the VXI standard.

Power Meter Overview

The HP E1416A VXI Power Meter is a single-channel Power Meter. The frequency and power range of signals you can measure, is determined by the Power Sensor being used. For information about the HP 8480 series Power Sensors you can use with the Power Meter, refer to the *Hewlett-Packard Sensor Catalog*, HP Part Number 5959-8751.

The main features of the Power Meter are listed in Table 1-1.

Table 1-1. Power Meter Main Features

Feature	Description
Frequency	Allows entry of test frequency for cal factor selection.
Loss/Gain	Allows measurement to be offset by ± 99 dB.
Resolution	Selection of 0.1, 0.01 and 0.001 dB. Auto filter mode selects the required number of averages for the chosen range and resolution.
Averaging	Selectable from 1 to 1024 readings in powers of 2.
Duty Cycle	Allows conversion from average power to peak (pulse) power, using entered duty cycle.
Sensor Tables	Power Sensor Data Tables for 10 Power Sensors can be entered and saved in non-volatile memory.
Save/Recall States	10 complete Power Meter operating states can be saved in non-volatile memory.

An abbreviated specification of the Power Meter is listed in Table 1-2. For a complete table of specifications refer to Appendix A.

Table 1-2. Power Meter Abbreviated Specifications

Parameter	Specification
Frequency	100 kHz to 50 GHz, sensor dependent.
Power Range	-70 to +44 dBm (100pW to 25W), sensor dependent.
Dynamic Range	50 dB in 10 dB ranges.
Results Units	W, dBm (absolute), PCT (%), dB (relative).
Accuracy	Instrumentation: Absolute mode ± 0.02 dB or $\pm 0.5\%$. In ranges 4 or 5 add sensor linearity percentage.
	Zero Set: $\pm 0.5\%$ of full scale on most sensitive range. Divide by 10 on each higher range.
Power Reference	1.00 mW (50 MHz oscillator factory set to $\pm 0.7\%$. Traceable to the United States National Institute of Standards and Technology).

Power Measurements - an introduction

Operating power level is frequently the critical factor in the design and ultimately in the performance and purchase of almost all radio frequency and microwave equipment. A 10W transmitter, for example, costs more than a 5W transmitter. Twice the power output means twice the geographical area is covered or 40% more range for a communication system.

Because power level is so important to the overall system, it is also very important in specifying the components that make up the system. Each component must receive the proper signal level from the previous component and pass the proper level to the succeeding component. If the power level becomes too low, the signal becomes obscured in noise. If the level gets too high, distortion results. It is at the higher operating power levels where every dB increase in level is often costly. The cost occurs in terms of complexity of design, expense of active devices, skill in manufacture, difficulty in testing, and decreased reliability. The increased cost per dB of level is especially true at microwave frequencies. At these frequencies, the maximum allowed power levels of solid state devices are close to minimum acceptable performance levels for systems.

The measurement of power is therefore critical at every level, from the overall system to the fundamental devices. Power is so important that it is frequently measured twice at each level, once by the manufacturer and again by the acceptor before beginning the next level. Many systems continuously monitor the power during ordinary operation. The large number and importance of power measurements dictates that the measurement equipment and technique be accurate, repeatable, traceable, and convenient.

Because many of the examples cited above used the term “signal level”, the natural tendency might be to measure voltage instead of power. At low frequencies, below about 100 kHz, power is usually calculated from voltage Measurements. As the frequency increases, power measurement becomes more popular and voltage or current are the calculated parameters.

At frequencies from about 30 MHz and up through the optical spectrum, the direct measurement of power is more accurate and easier. As the frequency approaches 1 GHz, power measurements become more important because voltage and current begin to lose their usefulness. One reason for this is that voltage and current vary with position along a lossless transmission line but power is constant. Another example of decreased usefulness is in waveguide where voltage and current are difficult to define and imagine. For these reasons, at radio and microwave frequencies, power flow is more measurable, easier to understand, and more useful than voltage or current as a fundamental quantity.

Getting Started

About This Chapter

This chapter introduces you to using the HP E1416A VXI Power Meter. The main sections of the chapter are:

- Front Panel Overview 2-1
- Programming Language 2-4
- Program Notes 2-4
- Introduction to Operation 2-5
- Making a Power Measurement 2-5
- Making a Relative Power Measurement 2-10

Note



If you are unpacking a new Power Meter, you should refer to the information contained in Chapter 5.

Front Panel Overview

This section contains information about the Power Meter's front panel connectors and annunciators. Refer to Figure 2-1.

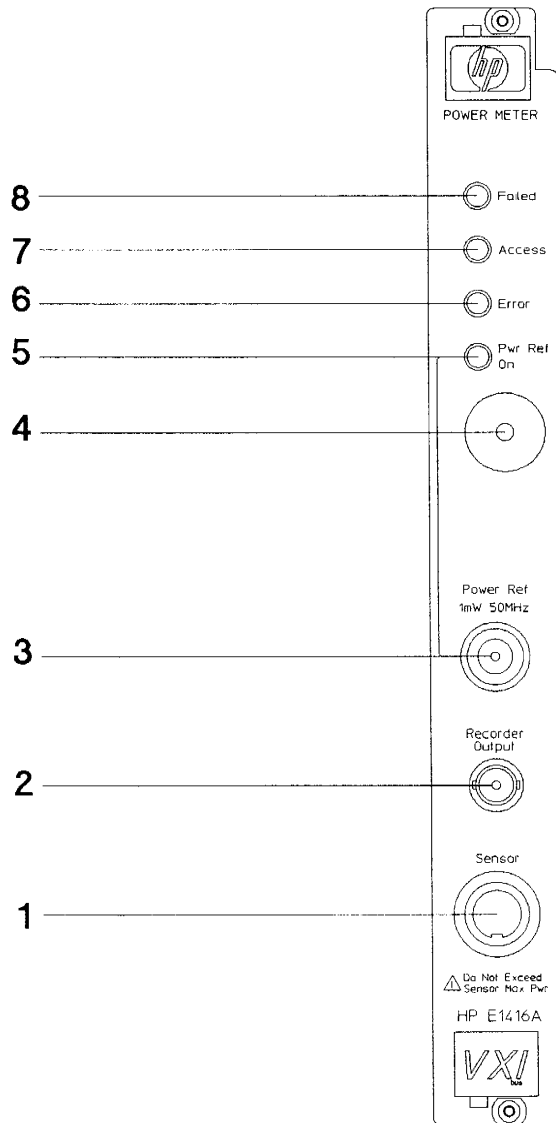

Figure 2-1. Power Meter Front Panel

- 1 **SENSOR INPUT CONNECTOR.** Connect the power sensor cable here.
- 2 **RECORDER OUTPUT.** BNC connector which outputs an analog 0 to 1 volt signal that is proportional to the power level measured by the Power Meter over a single range. The output impedance is 1 k Ω . Use this output to:
 - Drive a strip recorder to give a hard copy result of your power measurement with respect to time.
 - Connect to the Automatic Level Control input of a source to create an ALC loop.
- 3 **POWER REF.** 50 Ω , N-type connector which provides a 50 MHz, 1 mW signal for calibrating the Power Meter.
- 4 **CALIBRATION SEAL.** This seal covers the level adjustment for the POWER REF signal.

Caution



The POWER REF signal provides the reference against which all power measurements are made. This adjustment should only be performed by qualified personnel, under controlled conditions.

If the calibration seal is broken or missing, it may mean that the POWER REF signal has been maladjusted. This could introduce errors into your power measurements. In this situation it is recommended that the POWER REF signal is re-calibrated under controlled conditions, and the calibration seal replaced. (See Appendix B for details of the performance test to check the accuracy of the POWER REF signal).

- 5 **POWER REF ON.** This annunciator turns on when the Power Ref signal is switched on.
- 6 **ERROR.** This annunciator turns on if an error occurs during operation. Refer to Appendix C for more information about operating errors.
- 7 **ACCESS.** This annunciator turns on when data is passed between the mainframe command module and the Power Meter.
- 8 **FAILED.** This annunciator turns on if the Power Meter does not respond correctly during the mainframe's power-on sequence. If this occurs, refer to the *E1416A Service Manual*.

Programming Language

The example programs are written in the Hewlett-Packard BASIC language and assume the Power Meter is controlled from an HP 9000 Series 200/300 computer over HP-IB.

Note



If you are using a different computer, it must support secondary addressing on a GP-IB card. Also, you may need to modify the command structure in the example programs.

When using HP BASIC, a command is sent to the Power Meter with the OUTPUT statement:

```
OUTPUT 70907;"*IDN?"
```

The destination specified (70907), is the interface select code (7), plus the factory-set HP-IB address of the HP 75000 Series C mainframe command module (09). The Power Meter is set to allow access at secondary HP-IB address 07. The Power Meter command is enclosed between quotation marks.

Data from the Power Meter is entered into the computer using the the ENTER statement:

```
ENTER 70907;Variable$
```

Note



Additional information on programming using HP BASIC, can be found in the HP BASIC manual set.

Program Notes

1. The lines in the example programs which are preceded by !, are comment lines which have been included for program explanation and to increase program clarity. These lines are not necessary for correct operation of the programs and can be omitted.
2. The TMSL commands in the example programs are shown in their long form. The upper case letters denote the abbreviated form of the command. Use the abbreviated form for shorter program lines. For better program readability, use the long form. Refer to *Section 4 - Command Reference* for more information about TMSL command syntax.
3. The ? at the end of a command denotes a query command. This causes the Power Meter to output data when the command is completed.
4. The example programs use address 70907. Ensure that you modify the program for the address you are using.

Introduction to Operation

This section contains information on checking communications between the Power Meter, the VXI mainframe and the computer.

Power Meter Self-Test

Once the mainframe completes its power-on sequence, the Power Meter is ready to be used. Sending the self-test command is an easy way to verify that the Power Meter is being addressed correctly.

The command used to execute the self test is *TST?.

Note



1. You must connect a Power Sensor to the Power Meter before running the self-test. If a Power Sensor is not connected, the self-test will fail.
2. If the Power Meter does not respond to the self-test, the specified address may not be correct. Refer to Chapter 5 for information about setting the Power Meter's address.

```
10 !Send the self-test command to the Power Meter
20 !
30 OUTPUT 70907;"*TST?"
40 !
50 !Enter and display the self-test code
60 !
70 ENTER 70907;test_result
80 PRINT test_result
90 !
100 END
```

If the self-test passes, the Power Meter returns self-test code 0. If the self-test does not return 0, refer to the *E1416A Service Manual* for more information.

Making a Power Measurement

This section tells you how to make a power measurement. It describes the steps you should perform to make a calibrated measurement. These steps are:

- Clearing and resetting the Power Meter.
- Zeroing and calibrating the Power Meter.
- Entering the Calibration Factor for the signal you want to measure.
- Making the measurement.

Measurement Setup

For this measurement, the POWER REF output is used as a signal source. Connect the Power Sensor to the SENSOR connector and the Power Sensor input to the POWER REF connector.

Program

The following program can be used to make a calibrated power measurement.

Note



The values for the Reference Calibration Factor and the Calibration Factor in the program are 98.0 percent. Modify lines 80 and 180 for the Power Sensor you are using.

```
10  !Create I/O path name
20  ASSIGN @Power TO 70907
30  !Clear the Power Meter's Interface
40  CLEAR @Power
50  !Set the Power Meter to a known state
60  OUTPUT @Power;"*RST"
70  !Set the Reference calibration factor for sensor
80  OUTPUT @Power;":CALibration:RCF 98.OPCT"
90  !Zero and calibrate the power Meter
100 OUTPUT @Power;":CALibration:ALL?"
101 PRINT "ZEROING AND CALIBRATING THE POWER METER"
110 !Check to see what the outcome was
120 ENTER @Power;Success
130 IF Success=0 THEN
140     !Calibration cycle was successful
150     !
160     !
170     !Now set the measurement calibration factor
180     OUTPUT @Power;":CALibration:CFAC 98.OPCT"
190     !
200     !Now switch on the reference oscillator
210     OUTPUT @Power;":OUTPut:ROSCillator:STATE ON"
220     !
230     !Let the power meter and power sensor settle
231     PRINT "WAITING FOR THE POWER METER AND SENSOR TO SETTLE"
240     WAIT 1
250     !OK, ready to make a measurement (use *RST settings)
260     OUTPUT @Power;":MEASure:POWer:AC?"
270     ! ... and get the result
271     PRINT "MAKING THE MEASUREMENT"
280     ENTER @Power;Reading
290     !
300     PRINT "Reference oscillator measures ";Reading*1000;"mW."
310     !
320 ELSE
330     PRINT "THERE WAS A CALIBRATION ERROR!"
340 END IF
350 !
```

```
360 PRINT "PROGRAM COMPLETED"  
370 END
```

Program Description **LINE 20. ASSIGN @Power TO 70907**

The ASSIGN command is an HP BASIC command that creates an I/O path name and assigns that name to an I/O resource. In this program the I/O path name is @Power and it is assigned to the Power Meter at HP-IB address 70907. The ASSIGN command offers several advantages when used in a program:

- It speeds up data transfer.
- It makes program editing easier if you want to change the HP-IB address.

LINE 40. CLEAR @Power

The CLEAR command is an HP BASIC command that clears the Input buffer, the Output buffer and the command parser of the Power Meter. This puts the Power Meter into the correct state for receiving subsequent commands. To clear all the devices at select code 7, use the command CLEAR 7.

LINE 60 OUTPUT @Power; "*RST"

This line sets the Power Meter to its Reset (*RST) configuration as listed in Table 2-1.

Note



At power-on, the Power Meter is set to the same configuration as when it was powered-off.

Table 2-1. Power Meter Reset (*RST) Configuration

Parameter	Power-on Setting
Frequency	50 MHz
Reference Calibration Factor	100 PCT
Calibration Factor	100 PCT
Resolution	0.01 dB
Range	Auto
Filter	Auto
Measurement Units	Watts
Gain/Loss	0.00 dB, OFF
Relative measurement	0.00 dBm, OFF
Duty Cycle	100 PCT, OFF
Low Limit	-90.00 dBm
High Limit	+90.00 dBm
PWR REF	OFF
Input State	ON
Trigger Mode	Automatic Delay
Trigger Source	IMMediate
Trigger State	IDLE
Memory Protection	ON

LINE 80. OUTPUT @Power;" :CALibration:RCF 98.0PCT"

This line is used to set the Reference Calibration Factor (RCF). The Reference Calibration Factor is a measure of the Power Sensor's efficiency at 50 MHz. In the example program the RCF is set to 98.0 percent. This interprets as: for a power source at 50 MHz, the signal level at the output of the Power Sensor corresponds to 98% of the power level at the Power Sensor input. Modify this line for the Power Sensor you are using (the calibration information is provided on a label attached to the Power Sensor).

LINE 100. OUTPUT @Power;" :CALibration:ALL?

This line is a compound command which invokes a full calibration sequence. The sequence consists of:

- Zeroing
- Calibration

Zeroing adjusts the Power Meter's internal circuitry for a zero power reading with no power supplied to the sensor.

Note

-
1. Ensure that no RF power is applied to the SENSOR input during Zeroing.
 2. Zeroing will take approximately 5-20 seconds to complete.
-

Calibration calibrates the Power Meter to the Power Sensor being used. The Power Sensor must be connected to the Power Reference during calibration.

Note

Zeroing and calibration of the Power Meter is recommended:

1. When a 5° change in temperature occurs.
 2. When you change the Power Sensor being used.
 3. Every 24 hours.
-

LINES 120/130. These lines check the Power Meter to determine if the calibration has been completed. If the Power Meter returns a value of 0, then the calibration has passed.

LINE 180. `OUTPUT @Power;":CALibration:CFAC 98.0PCT"`

This line is used to set the Calibration Factor. The Calibration Factor is a compensation value for the effective efficiency of the Power Sensor at a specific frequency. In this program the 50 MHz Power Ref signal is being used as a source, so the Calibration Factor is the same value as the Reference Calibration Factor.

LINE 210. `OUTPUT @Power;":OUTPut:ROSCillator:STATe ON"`

This line switches on the POWER REF signal.

LINE 240. `WAIT 1`

This line causes the program to pause for 1 second. This delay is to allow the analog circuitry in the Power Meter and the Power Sensor to settle after receiving a large change in input level.

LINE 260. `OUTPUT @Power;":MEASure:POWer:AC?"`

This line measures the power. The result units are watts. If you want the result in dBm, add this line to the program:

```
255 OUTPUT @Power;":UNIT:POWer DBM"
```

You also need to modify line 300 as follows:

```
300 Print "Reference oscillator measures ";Reading;"dBm."
```

Making a Relative Power Measurement

This section explains how you can use the Power Meter to make a relative power measurement. Figure 2-2 shows a typical application for this feature.

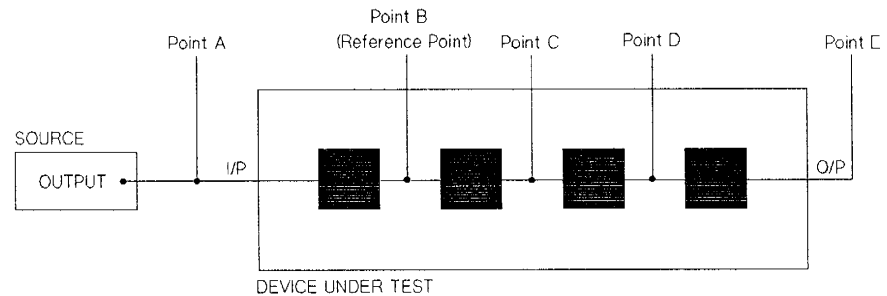

Figure 2-2. Relative Power Measurement Application

You measure the power at the reference point, then set the Power Meter to make any subsequent power measurements with respect to the power level at this point.

Measurement Setup

For this measurement, the POWER REF output is used as a signal source. Connect the Power Sensor to the to the SENSOR connector and the Power Sensor input to the POWER REF connector.

Program

The following program can be used to make a relative power measurement.

```
10 !Create I/O path name
20 ASSIGN @Power TO 70907
30 !Clear the Power Meter's Interface
40 CLEAR @Power
50 !Set the Power Meter to a known state
60 OUTPUT @Power;"*RST"
70 !Set the Reference calibration factor for sensor
80 OUTPUT @Power;":CALibration:RCF 98.0PCT"
90 !Zero and calibrate the power Meter
100 OUTPUT @Power;":CALibration:ALL?"
110 PRINT "ZEROING AND CALIBRATING THE POWER METER"
120 !Check to see what the outcome was
130 ENTER @Power;Success
140 IF Success=0 THEN
150 !Calibration cycle was successful
160 !Take the the readings relative to -10 dBm
170 OUTPUT @Power;":POWER:REFERENCE -10dBm"
180 OUTPUT @Power;":POWER:REFERENCE:STATE ON"
190 !Set the measurement units to dBm
200 OUTPUT @Power;":UNIT:POWER DBM"
210 !Now set the measurement calibration factor
220 OUTPUT @Power;":CALibration:CFAC 98.0PCT"
```

```

230      !
240      !Now switch on the reference oscillator
250      OUTPUT @Power;":OUTPut:ROSCillator:STATe ON"
260      !
270      !Let power meter and sensor settle
280      PRINT "WAITING FOR THE POWER METER AND SENSOR TO SETTLE"
290      WAIT 5
300      !OK, ready to make a measurement
310      OUTPUT @Power;":MEASure:POWer:AC?"
320      ! ... and get the result
330      ENTER @Power;Reading
340      PRINT "Relative to -10dBm, the.... ."
350      PRINT "Reference oscillator measures ";Reading;"dB rel."
360      !
370      ELSE
380          PRINT "THERE WAS A CALIBRATION ERROR!"
390      END IF
400      !
410      PRINT "PROGRAM COMPLETED"
420      END

```

Program Description

The main body of the program is similar to the program used in *Making a Power Measurement*, so only the additional lines needed to make a relative power measurement are explained.

LINE 170. OUTPUT @Power;":POWer:REFEreNce -10dBm"

This line sets the reference power level to -10 dBm.

LINE 180. OUTPUT @Power;":POWer:REFEreNce:STATe ON"

This line enables the relative power measurement function. To disable the relative measurement function, use the following command:

```
OUTPUT @Power;":POWer:REFEreNce:STATe OFF"
```

LINE 200. OUTPUT @Power;":UNIT:POWer DBM"

This line sets the result units to dBm.

Understanding the Power Meter

About This Chapter

This chapter describes the parameters which configure the Power Meter and helps you determine settings to optimize performance. This chapter contains the following sections:

- Calibrating the Power Meter 3-2
- Using MEASure and CONFigure 3-4
- How to make measurements
 - Using Data Tables 3-6
 - Setting the Range, Resolution and Filter 3-14
 - Loss and Gain 3-18
 - Limits Checking 3-19
 - Measuring Pulsed signals 3-22
 - Using the HP 11722A Power Sensor 3-24
- Triggering the Power Meter 3-26
- Status Reporting 3-28
- Saving and Recalling Power Meter Configurations 3-39

Calibrating the Power Meter

This section explains how to calibrate the Power Meter. To calibrate the Power Meter you need to perform two steps:

1. Zeroing
2. Calibration

Zeroing adjusts the Power Meter's internal analog circuitry for a zero power reading with no power supplied to the Power Sensor. The Power Sensor must not be connected to a power source during zeroing.

Calibration calibrates the Power Meter to the Power Sensor being used. The Power Reference output is used as the signal source for calibration. An essential part of calibrating is setting the correct Reference Calibration Factor for the Power Sensor you are using.

Setting the Reference Calibration Factor

The Reference Calibration Factor can be set by:

1. Entering the value into the Power Meter using the CAL:RCF command. This method is used when the Single Correction system is enabled.
2. Transferring a Data Table into Measurement Space and enabling the Data Table system. The Reference Calibration Factor is automatically set by the Power Meter using the Reference Calibration Factor value stored in the Data Table. Refer to *Using Data Tables* in this section for more information.

Examples

- a. To enter a Reference Calibration Factor of 98.6PCT, using the Single Correction system, the following command would be used:

```
CAL:RCF 98.6PCT
```

- b. To automatically set the Reference Calibration Factor, you have to create a Data Table as described in *Using Data Tables*. After the Data Table is created the following commands would be used:

```
CAL:CSET:SEL "SENSOR_1"    Transfer data table named  
                           SENSOR_1 into Measurement  
                           Space  
CAL:CSET:STAT ON          Enable the Data Table system
```

Querying the Reference Calibration Factor

To find out the current Reference Calibration Factor, you use the following command:

```
CAL:RCF?
```

This returns the value, irrespective of the method used to set it.

Zeroing The command used to Zero the Power Meter is:

```
CAL:ZERO:AUTO ONCE
```

The command assumes that the Power Sensor is not connected to a power source. If the reference output is ON, then the command switches it OFF for the duration of zeroing. Zeroing will take between 5 and 20 seconds to complete, depending on the type of Power Sensor being used.

When to Zero? It is recommended that you zero the Power Meter:

1. When a 5° change in temperature occurs.
2. When you change Power Sensors.
3. At least once every 24 hours.

Calibration The command used to calibrate the Power Meter is:

```
CAL:AUTO ONCE
```

The command assumes that the Power Sensor is connected to the power reference. It is recommended that you zero the Power Meter before calibrating.

Calibration Sequence This feature allows you to perform a complete calibration sequence with a single command. The command is:

```
CAL:ALL?
```

The Power Sensor should be connected to the power reference. The command enters a number into the output buffer when the sequence is completed. If the result is 0 the sequence was successful. If the the result is 1 the sequence failed. Refer to *Section 4 Command Reference* for more information.

Note



The CAL:ALL command is identical to the CAL:ALL? command except that no number is returned to indicate the outcome of the sequence. Use the CAL:ALL command if you want to use the time during which the Power Meter is performing the calibration sequence to send commands to other modules in the VXI mainframe. You can examine the Questionable Status Register to discover if the sequence has passed or failed. See *Status Reporting* in this section for more information.

Using MEASure and CONFigure

The commands MEASure:POWer:AC?, CONFigure, READ?, INITiate and FETCh? give you a choice between high level commands that are very easy to use, and low level commands that give you more complete control over the Power Meter. When you use a high level command such as MEASure:POWer:AC?, you only need to know about the quantity you are trying to measure. If you use the low level commands, you must understand the details of the Power Meter settings and triggering.

Using MEASure

Using the MEASure:POWer:AC? command is equivalent to sending the following commands:

```
ABORt
CONFigure:POWer:AC <conf_parm>
READ?
```

The command also does the following:

INIT:CONT OFF	<i>Sets the Power Meter to make 1 trigger cycle when INIT is sent</i>
TRIG:SOUR IMM	<i>Sets the Power Meter to make the measurement immediately</i>
TRIG:DEL:AUTO ON	<i>Enables automatic delay before making the measurement</i>
INP:STAT ON	<i>Sets the HP 11722A Power Sensor to Sensor Path</i>
AVER:COUN:AUTO ON	<i>Enables automatic filter length selection</i>

Because the measurement is taken immediately, variations to the Power Meter configuration are limited to the parameters within the MEASure command (i.e. range, resolution and frequency).

For example the command:

```
MEAS:POW:AC? 20DBM, 0.1DB
```

sets the range to 20 dBm and the resolution to 0.1 dB, then makes the measurement.

Using CONFigure

Prior to making a measurement, the Power Meter can be set-up using the CONFigure command. CONFigure does not make the measurement after setting the configuration. Therefore you can set the range, resolution and frequency with the CONFigure command then change the setup using the lower level commands. For example if you want to make a measurement without trigger delay, MEASure cannot be used since it turns AUTO:DELay ON then makes the measurement. Setting the configuration with CONFigure allows you to do this:

```
CONF:POW:AC 20DBM, 0.1DB
TRIG:DEL:AUTO OFF
```

Note

The range and resolution can also be set using the SENSE command subsystem. Refer to *Section 4 - Command Reference* for more information.

Making Measurements with CONFIGure

To make a measurement after setting the configuration use:

READ?

or

INIT

The READ? command executes the INIT command then returns the result to the output buffer.

The INIT command places the result in memory. You use the FETCH? command to transfer the result to the output buffer.

Note

READ? and INIT will make the measurement immediately if TRIG:SOUR is set to IMM. If the trigger source is changed following the CONFIGure command, the INIT command will place the Power Meter in the wait-for-trigger state. The measurement will be taken when the the appropriate trigger occurs. See *Section 4 - Command Reference* for more information.

Using Data Tables

This section describes how to use Data Tables. Data Tables can be used to store the measurement calibration factors (supplied with each Power Sensor) in the Power Meter. These calibration factors are used to correct measurement results.

Overview There are two ways to provide correction data to the Power Meter:

- **The Single Correction system.**
- **The Data Table system.**

To make a calibrated power measurement using the Single Correction system you perform the following steps:

1. Zero and Calibrate the Power Meter. Before carrying out the calibration, you set the Reference Calibration Factor for the Power Sensor you are using.
2. Set the Calibration Factor to the value for the frequency of the signal you want to measure.
3. Make the measurement.

If you are using several different Power Sensors to cover the frequency and power range you want to measure, the Single Correction system has several disadvantages:

- a. In step 2, if the frequency of the signal is not listed on the Power Sensor calibration table, you have to calculate the Calibration Factor.
- b. When you change the measurement frequency or the Power Sensor, you have to remember to change the setting of the Calibration Factor.
- c. When you change the Power Sensor you have to remember to change the Reference Calibration Factor before calibrating the Power Meter.

The **Data Table** system provides a quick and convenient method for making power measurements at a range of frequencies using one or more Power Sensors. You can store up to 10 Data Tables in the Power Meter. Each table can contain a maximum of 80 Frequency/Calibration Factor entries. Each table must contain the Reference Calibration Factor for the Power Sensor.

Figure 3-1 illustrates how the Data Table system operates.

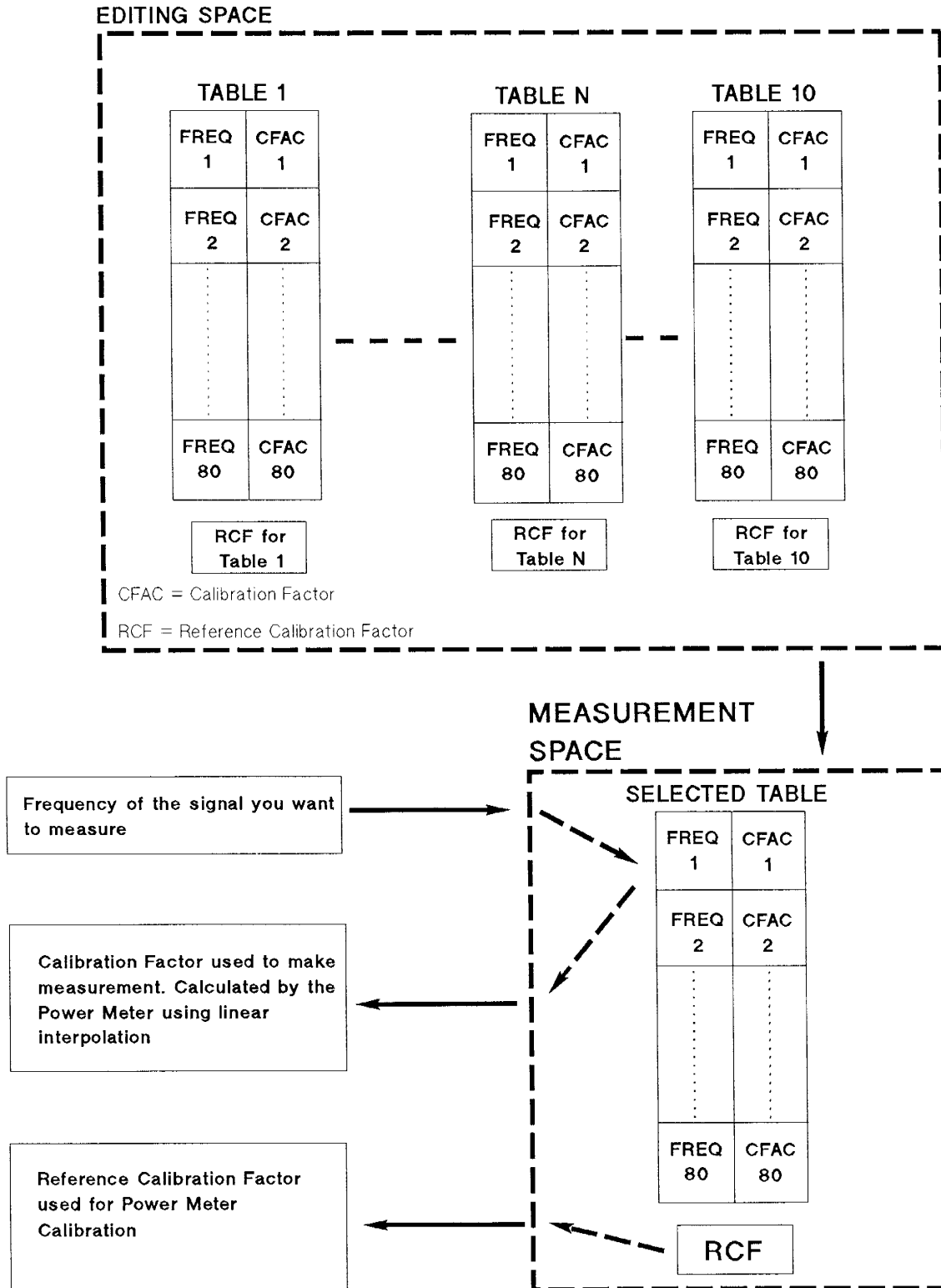

Figure 3-1. Power Sensor Data Table System

To use the Data Table system you :

1. Create and edit a table in Editing Space.
2. Transfer the table from Editing Space to Measurement Space.
3. Enable the Data Table system (this disables the Single Correction System).
4. Zero and Calibrate the Power Meter. The Reference Calibration Factor used during Calibration is automatically set by the Power Meter using the Reference Calibration Factor stored alongside the table.
5. Specify the frequency of the signal you want to measure. The Calibration Factor is automatically set by the Power Meter, using linear interpolation (between the frequency values stored in the table).
6. Make the measurement.

To Create and Edit Tables

You create and edit Data Tables in Editing Space using the MEMORY Subsystem.

Procedure

1. To list the tables currently stored in the Power Meter, you use the following commands:

```
MEM:CAT?  
enter statement
```

2. An example response is:

```
"SENSOR_1", "SENSOR_2"
```

3. If there are no tables stored in the Power Meter a null string is returned ("").

Note



The Power Meter is shipped with a set of Data Tables. The data in these tables is based on statistical averages for a number of Hewlett-Packard Power Sensors. The Power Sensors are:

```
TBL100PCT  
HP8481A  
HP8482A  
HP8483A  
HP8484A  
HP8485A  
HP8486A  
Q8486A  
R8486D  
HP8487A
```

TBL100PCT is a Data Table in which the Reference Calibration Factor and Calibration Factors are 100PCT. This table can be used during Performance Testing the Power Meter.

4. If there are 10 tables stored in the Power Meter and you want to add another table, you need to delete a table. For example to delete a table named SENSOR_1, you use the following commands:

```
MEM:PROT OFF
MEM:DEL "SENSOR_1"
MEM:PROT ON
```

Caution



The MEM:PROT command is used to switch off and on Memory Protection. If MEM:PROT? returns ON, then the MEM:DEL command will not be carried out.

If you set MEM:PROT OFF, it is recommended that you re-lock the memory using the MEM:PROT ON command, after you complete your editing.

You can delete all the stored tables using the following command:

```
MEM:DEL ALL
```

Note



Use the MEM:DEL ALL command with extreme caution. The command deletes all the tables stored in Editing Space.

5. You create a new table using the following command:

```
MEM:DEF "SENSOR_5"
```

Note



For more information about rules for naming tables, refer to *Naming Data Tables* on Page 3-10.

6. To edit the last table you created (SENSOR_5), SElect the table, then enter the data.

```
MEM:SEL
MEM:FREQ 100kHz,99.9 GHz
MEM:CFAC 97.6PCT, 94.9PCT
MEM:RCF 98.6PCT
```

These commands:

- a. Select the last table you created.
- b. Enter 2 frequency points.
- c. Enter 2 Calibration Factors.
- d. Enter the Reference Calibration Factor.

Note



1. If you want to enter data into another table, specify the table name after the MEM:SEL command.
 2. Any legal suffix multiplier is allowed for frequency data. If no units are specified, the Power Meter assumes the data is Hz.
 3. PCT is the only legal unit for Calibration Factors and Reference Calibration Factor and can be omitted.
 4. The frequency and calibration data must be within range. See *Section 4 - Command Reference* for more information.
 5. The number of Frequency and Calibration Factor data points must be equal. The maximum number of data pairs is 80. This is not checked until the table is transferred to Measurement Space.
 6. Entries in the data lists must be in a 1-to-1 correspondence. For example the *n*th data point in the frequency list must be the one associated with the *n*th data point in the Calibration Factor list. The Power Meter sorts the data pairs by frequency. Therefore the frequency list does not have to be sent in frequency order.
 7. Ensure that the frequency points you use cover the frequency range of the signals you want to measure. If you measure a signal with a frequency outside the frequency range defined in the table, then the Power Meter uses the highest or lowest frequency point in the table to calculate the Calibration Factor.
 8. To make subsequent editing of a table easier, it is recommended that you retain a copy of your data in a program.
-

Naming Data Tables

The following rules apply to table names:

1. Table names can be one of the following types:
 - a. IEEE 488.2 *<character program data>* as defined in IEEE 488.2 Section 7.1.1
 - b. A string
2. If the name is *<character program data>*, then the following rules apply:
 - a. The table name must consist of no more than 12 characters.
 - b. The first character must be an upper or lower case alpha character (**a-z, A-Z**).
 - c. All other characters must be upper or lower case alpha, or numeric (**0-9**), or an underscore (**_**).
 - d. No other characters are allowed.
3. If the name is *<character program data>*, then all subsequent MEM:CAT? or MEM:CAT:TABLE commands return the alpha characters in upper case. (MEM:DEF "Sensor_1", then MEM:CAT? returns "SENSOR_1").

4. If the name is a string, then the following rules apply:
 - a. The table name must consist of no more than 20 characters.
 - b. The first character must be an upper or lower case alpha character (**a-z, A-Z**).
 - c. All other characters must be upper or lower case alpha, or numeric (0-9), or an underscore (_).
 - d. No other characters are allowed.
5. If the name is a string, then all subsequent MEM:CAT? or MEM:CAT:TABLE commands return the alpha characters with the case preserved. (MEM:DEF "SeNsoR_1", then MEM:CAT? returns "SeNsoR_1").
6. For both types, no spaces are allowed in the name.
7. The examples in this manual use the string format for table names.

To Review Table Data.

To review the data stored in a table, you use the following commands:

MEM:SEL "SENSOR_1"	<i>Make the table named SENSOR_1 active in editing space</i>
MEM:SEL?	<i>Query command which returns the name of the table active in editing space</i>
MEM:FREQ:POIN?	<i>Query command which returns the number of frequency points stored</i>
MEM:FREQ?	<i>Query command which returns the frequencies stored in the table (in Hz)</i>
MEM:CFAC:POIN?	<i>Query command which returns the number of Calibration Factor points stored in the table</i>
MEM:CFAC?	<i>Query command which returns the calibration factors stored in the table (in %)</i>
MEM:RCF?	<i>Query command which returns the value of the Reference Calibration Factor stored in the table (in %)</i>

Note



If you try to SElect a table which does not exist, the error "Non-existent name" is generated by the Power Meter.

To Modify Data

You can modify the Reference Calibration Factor by SElecting the table and resending the Reference Calibration Factor. If you need to modify the Frequency and Calibration Factor data stored in a table, you need to resend the complete data lists. There are two ways to do this:

1. If you have retained the original data in a program, edit the program and resend the data.
2. Use the Query commands shown in *To Review Table Data*, to enter the data into your computer. Edit this data, then resend it.

To Transfer a Table

After you have created the Data Table, you transfer it from Editing Space to Measurement Space. Use the following command to move table SENSOR_1:

```
CAL:CSET:SEL "SENSOR_1"
```

Note



1. If you do not specify a table name, the table currently active in Editing Space is transferred.
2. When the table is transferred, the Power Meter checks that the number of Frequency points and Calibration Factor points defined in the table are equal. If there is a mismatch in the number of points, an error is generated.
3. To find out which table is in Measurement Space, use the query command:

```
CAL:CSET:SEL?
```

To Enable the Data Table System.

When you enable the Data Table System, the Single Correction System is disabled. To enable the Data Table System you use the following command:

```
CAL:CSET:STAT ON
```

Note



1. If you set CAL:CSET:STATe ON and no table is in Measurement Space, an error is generated (CAL:CSET:STATe is left OFF).
 2. When CAL:CSET:STATe is set to ON, the Reference Calibration Factor used during calibration is the value stored in the Table.
-

Making the Measurement

To make the power measurement, you set the Power Meter for the frequency of the signal you want to measure. The Power Meter automatically sets the Calibration Factor. Use the following commands:

```
MEAS:POW:AC? -20 DBM,0.01 DB,2MHZ
enter statement
```

Alternatively, you can set the frequency using the [:SENSE]:FREQ <frequency> command as follows:

```
FREQ 2MHZ
```

The CONFIGure and MEASURE:POWER:AC? commands set CAL:CSET:STAT ON if a frequency is included in the parameter list.

Note



1. If the measurement frequency does not correspond directly to a frequency in the table, the Power Meter calculates the Calibration Factor using linear interpolation.
2. If you enter a frequency outside the frequency range defined in the table, then the Power Meter uses the highest or lowest frequency point in the table to set the Calibration Factor.
3. To find out the value of the Calibration Factor being used by the Power Meter to make a measurement, use the query command:

```
CAL:CFAC?
```

This is valid for the Single Correction and Data Table Systems.

4. To find out the value of the RCF being used, use the query command:

```
CAL:RCF?
```

This is valid for the Single Correction and the Data Table Systems.

Setting the Range, Resolution and Filter

This section provides an overview of setting the range, resolution and the filter. For more detailed information about these features, you should refer to *Section 4 - Command Reference*.

Range

You can either set the range in which you want the Power Meter to make the power measurement or you can set the Power Meter to autoranging.

Setting the Range

For most Power Sensors the Power Meter is able to measure power on five ranges. For example if UNIT:POW is set to DBM and you are using an HP 8482A Power Sensor these ranges correspond to five decades:

- 30 to -20 dBm
- 20 to -10 dBm
- 10 to 0 dBm
- 0 to +10 dBm
- +10 to +20 dBm

If UNIT:POW is set to W, then the ranges are:

- 0.001 to 0.01 mW
- 0.01 to 0.1 mW
- 0.1 to 1 mW
- 1 to 10 mW
- 10 to 100 mW

Refer to Figure 3-2, which illustrates part of the ranges for an HP 8482A Power Sensor.

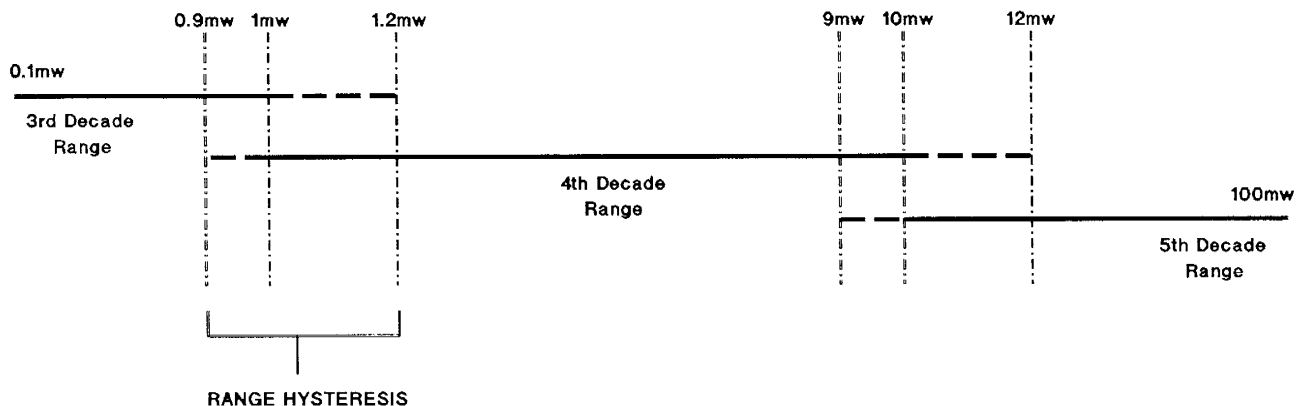

Figure 3-2. HP 8482A Decade Ranges

If you want to specify a particular measurement range for the Power Meter, you enter the power level you want to measure. However, because there is an overlap between adjacent measurement decade ranges (see Figure 3-2), a conflict would arise if the power level fell within the 30% overlap. You must specify if the value you want to measure is the highest power level you want to measure (UPPer) or the lowest power level you want to measure (LOWer). If you do not specify UPPer or LOWer the Power Meter will default to UPPer.

Commands which specify [:SENSe]:POWer:RANGe[:UPPer] *value* mean that the Power Meter should select a range assuming that this is the highest power to be measured. If in a particular range, this value is less than 120% of the full-scale (of that range measured in linear units) the Power Meter will choose the range below. For example if you are using an HP 8482A Power Sensor the following commands will select the indicated range.

POWer:RANGe 1.05 mW	<i>3rd decade range</i>
POWer:RANGe 1.2 mW	<i>3rd decade range</i>
POWer:RANGe 1.21 mW	<i>4th decade range</i>
POWer:RANGe 10.6 mW	<i>4th decade range</i>
POWer:RANGe 14 mW	<i>5th decade range</i>

Commands which specify [:SENSe]:POWer:RANGe:LOWer *value* mean that the Power Meter should select a range assuming that this is the lowest power to be measured. If in a particular range, this level is more than 90% of the full-scale (of that range measured in linear units) the Power Meter will choose the range above. For example if you are using an HP8482A Power Sensor the following commands will select the indicated range.

POWer:RANGe:LOWer 0.89 mW	<i>3rd decade range</i>
POWer:RANGe:LOWer 1.2 mW	<i>4th decade range</i>
POWer:RANGe:LOWer 9.51 mW	<i>5th decade range</i>
POWer:RANGe:LOWer 8.6 mW	<i>4th decade range</i>
POWer:RANGe:LOWer 14 mW	<i>5th decade range</i>

Autoranging

To enable autoranging you use the following command;

```
POWer:RANGe:AUTO ON
```

Use autoranging when you are not sure of the power level you will be measuring.

Note



If you require maximum speed for your application then you should set a measurement range since autoranging increases the time taken to complete a measurement.

Resolution

You set the resolution of your measurements using the `[:SENSe]:POWer:RESolution <res_n> <res_suffix>` command. There are three levels of resolution available as listed in the following tables.

Parameter Name	Parameter Type	Range of Values	Default Units
<i>res_n</i>	numeric	<i>see next table</i> DEF MIN MAX	Defined by UNIT:POW

UNIT:POW	MIN	DEF	MAX	RESOLUTION UNITS (<i>res_suffix</i>)
DBM	0.001	0.01	0.1	dB
W	0.01% of full scale	0.1% of full scale	1% of full scale	< <i>suffix_multiplier</i> >W

Note



- Resolution can be specified in dB or W. If *res_suffix* is omitted, then the units assumed are defined by UNIT:POWer.
- If UNIT:POWer is DBM, then independent of range, resolution can always be set to 0.1, 0.01 or 0.001 dB.
- If UNIT:POWer is W then resolution is determined by the range the Power Meter is currently set to. For example, to set a resolution that is 1% of full scale, when POW:RANG:UPP 1 MW the following command would be used:

```
POW:RES 1E-05 W
```

Similarly to set 0.1% and .01% resolutions the following commands would be used:

```
POW:RES 1E-06 W
```

```
POW:RES 1E-07 W
```

- The Power Meter converts the number to one of the allowable resolutions. The breakpoint between resolutions is the midpoint between scales. For example, setting POW:RANG:UPP 1 MW, then POW:RES 0.0049 MW, sets the resolution to to 0.001 mW (0.1%). If POW:RES is set to 0.0051 mW, the resolution is set to 0.01 mW (1%).
- If you require maximum speed for you application, then set the Power Meter for the lowest resolution you can use.

Filter

The Power Meter has a digital filter. The digital filter is used to reduce noise, obtain the desired resolution and to reduce jitter in the measurement results. You can select the filter length or you can set the Power Meter to auto filter mode

Auto Filter Mode

To enable auto filter mode you use the following command:

```
AVERage:AUTO:STATe ON
```

If AVER:COUN:AUTO is set to ON, auto filter length selection is enabled. In auto filter mode, the Power Meter, automatically sets the number of readings averaged together to satisfy the filtering requirements for most power measurements. The number of readings averaged together depends on the resolution and the power range in which the Power Meter is currently operating in. The following table lists the number of readings averaged for each range and resolution when the Power Meter is in auto filter mode.

	0.1 dB (1%) Number of Averages	0.01 dB (0.1%) Number of Averages	0.001 dB (0.01%) Number of Averages
Range Decade 1	8	128	128
Range Decade 2	1	8	256
Range Decade 3	1	2	32
Range Decade 4	1	1	16
Range Decade 5	1	1	8

Filter Length

You specify a filter length using the following command:

```
AVERage:COUNT filter_length
```

The range of values for *filter_length* is 1 to 1024. Specifying this command disables automatic filter length selection. If a numeric parameter is specified which is not a binary multiple, the Power Meter rounds the value of *filter_length* to the nearest power of 2. For example if you specify AVER:COUN 5, the Power Meter sets the value of *filter_length* to 4. If you specify AVER:COUN 7, the Power Meter sets the value of *filter_length* to 8. Increasing the value of *filter_length* increases measurement accuracy. However, the time taken to make a power measurement is increased.

Loss and Gain

The Power Meter can be configured to compensate for signal loss or gain in your test set-up (for example, to compensate for the loss of a 10 dB directional coupler). You use the SENSE command subsystem to configure the Power Meter. The LOSS and GAIN commands form a coupled system. This means that if you set a LOSS of -10 dB and query the GAIN, the result you receive back is +10 dB.

An example program using this feature is shown below.

```
10    !Create I/O path name
20    ASSIGN @Power TO 70907
30    !Clear the Power Meter's Interface
40    CLEAR @Power
50    !Set the Power Meter to a known state
60    OUTPUT @Power;"*RST"
70    !Set the measurement units to dBm
80    OUTPUT @Power;"UNIT:POW DBM"
90    !Now set the Power Meter for a LOSS of -10 dB
100   OUTPUT @Power;":CORRection:LOSS -10"
110   !Now enable the LOSS correction
120   OUTPUT @POWER;"CORRection:LOSS:STATe ON"
130   !Now enable global correction
140   OUTPUT @POWER;":CORRection:STATe ON"
150   !OK, ready to make a measurement
160   OUTPUT @Power;":MEASure:POWer:AC?"
170   ! ... and get the result
180   PRINT "MAKING THE MEASUREMENT"
190   ENTER @Power;Reading
200   !
210   PRINT "The measurement result is ";Reading;"dBm."
220   END
```

Comments

1. You need to enable 2 different levels of correction; the global correction (line 120) and loss correction (line 140).
2. The range of values for LOSS and GAIN is +99.99 dB to -99.99 dB. You can use DEF|MIN|MAX to set the LOSS or GAIN.
3. To query the current value of LOSS or GAIN use the following commands:

```
CORR:GAIN?
CORR:LOSS?
```

Limits Checking

The Power Meter can be configured to check the power being measured against an upper and/or lower limit value. A typical application for this feature is shown in Figure 3-3 and Figure 3-4.

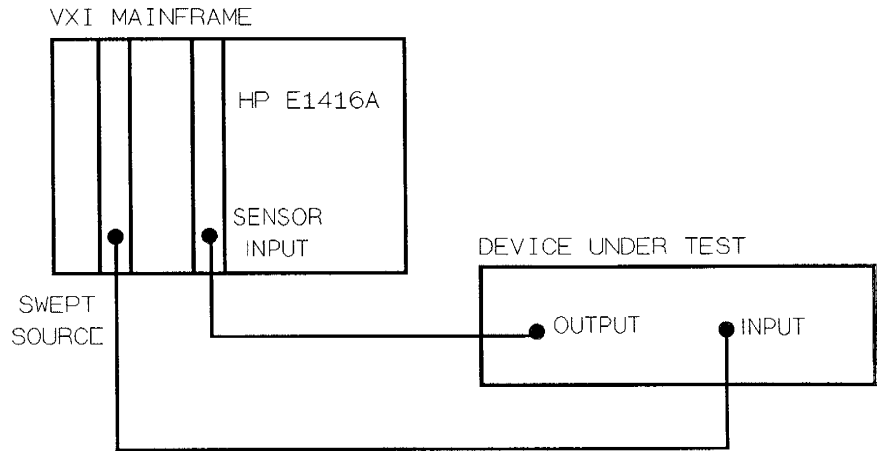

Figure 3-3. Limits Checking Application

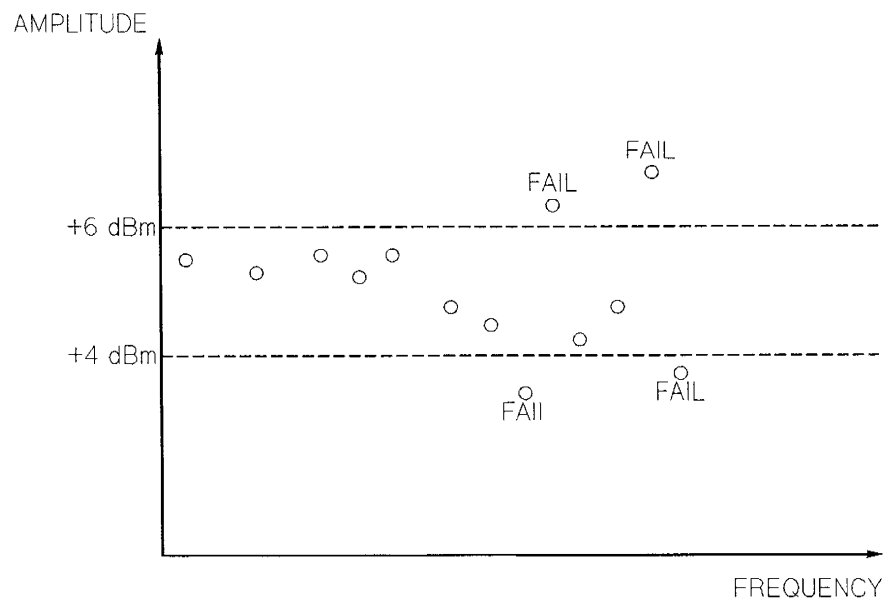

Figure 3-4. Limits Checking Results

In this application a swept frequency signal is supplied to the input of the Device Under Test. The Power Meter measures the output power. The limits have been set at +6 dB and +4 dB. A fail occurs each time the output power exceeds these limits. You use the CALCulate command subsystem to configure the Power Meter for limits checking. The following example program shows how to set the limits at +4 and +6 dB.

```

10 !Create I/O path name
20 ASSIGN @Power to 70907
30 !Clear the Power Meter's Interface
40 CLEAR @Power
50 !Set the Power Meter to a known state
60 OUTPUT @Power;"*RST"
70 !Set the measurement units to dBm
80 OUTPUT @Power;"UNIT:POWer DBM "
90 !Set the upper limit to +6 dBm
100 OUTPUT @Power;"CALCulate:LIMit:UPPer 6"
110 !Set the lower limit to +4 dBm
120 OUTPUT @Power;"CALCulate:LIMit:LOWer 4"
130 !Check the limits
140 OUTPUT @Power;"CALCulate:LIMit:UPPer?;LOWer?"
150 ENTER @Power;A,B
160 PRINT A,B
170 !Enable Limits Checking
180 OUTPUT @Power;"CALCulate:LIMit:STATe ON"
190 END

```

Note



1. There is a lower level enable command for UPPER and LOWER limit. At *RST these are set to ON. Ensure that the global enable and the lower level enable(s) are set to ON for limits checking.
2. The range of values you can set for UPPER and LOWER limits is -90.00 dBm to +90.00 dBm

Checking For Limit Failures

There are two ways to check for limit failures; using the CALCulate:LIMit:REPort? or the CALCulate:LIMit:FCOount? commands or using the STATus command subsystem.

Using CALCulate

Using CALCulate to check for limit failures in Figure 3-4 would return the following results.

CALC:LIM:FCO?	<i>Returns the total number of limit failure, in this case 4</i>
CALC:LIM:REP?	<i>Returns 1 if there has been 1 or more limit failures or +9.9100E+37 if there have been no limit failures. In this case 1 is returned</i>

Note



For more detailed information about these commands, refer to the CALCulate command subsystem in Chapter 4.

Using STATus

You can use the STATus subsystem to generate an SRQ to interrupt your program when a limit failure occurs. This is a more efficient

method than using CALCulate, since you do not need to check the limit failures after every power measurement.

Refer to *Status Reporting* in this chapter and *Chapter 4 - Command Reference* for more information.

Measuring Pulsed Signals

The Power Meter can be used to measure the power of a pulsed signal. The measurement result is a mathematical representation of the pulse power rather than an actual measurement. The Power Meter measures the average power of the pulsed input signal and then divides the measurement result by the duty cycle value to obtain the pulse power reading.

Making the Measurement

An example of a pulsed signal is shown in Figure 3-5.

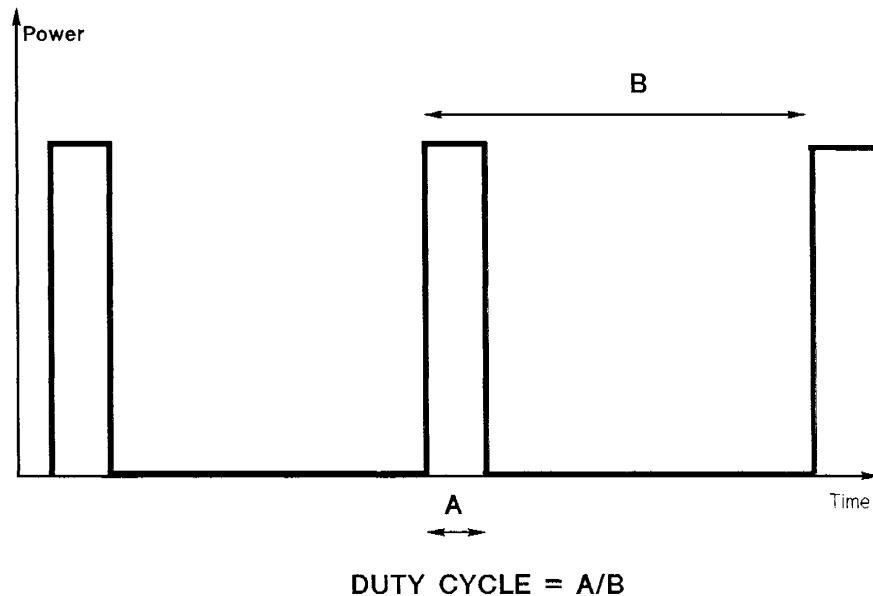

Figure 3-5. Pulsed Signal

The duty cycle of this pulse is 14%.

You use the SENSE command subsystem to configure the Power Meter to measure a pulsed signal. An example program to measure this signal is shown below.

```
10 !Create I/O path name
20 ASSIGN @Power TO 70907
30 !Clear the Power Meter's Interface
40 CLEAR @Power
50 !Set the Power Meter to a known state
60 OUTPUT @Power;"*RST"
70 !Set the Reference calibration factor for sensor
80 OUTPUT @Power;":CALibration:RCF 98.OPCT"
90 !Zero and calibrate the power Meter
100 OUTPUT @Power;":CALibration:ALL?"
101 PRINT "ZEROING AND CALIBRATING THE POWER METER"
110 !Check to see what the outcome was
120 ENTER @Power;Success
```

```

130 IF Success=0 THEN
140     !Calibration cycle was successful
150     !
160     !
170     !Now set the measurement calibration factor
180     OUTPUT @Power;":CALibration:CFAC 98.OPCT"
190     !
200     !Now set the Power Meter for a duty cycle of 14PCT
210     OUTPUT @Power;":CORRection:DCYCLe 14PCT"
220     !
230     !Now enable the duty cycle correction
240     OUTPUT @POWER;":DCYCLe:STATe ON"
250     !
260     !Now enable global correction
270     OUTPUT @POWER;":CORRection:STATe ON"
280     !
290     !OK, ready to make a measurement
300     OUTPUT @Power;":MEASure:POWer:AC?"
310     ! ... and get the result
320     PRINT "MAKING THE MEASUREMENT"
330     ENTER @Power;Reading
340     !
350     PRINT "The measurement result is ";Reading*1000;"mW."
360     !
370 ELSE
380     PRINT "THERE WAS A CALIBRATION ERROR!"
390 END IF
400     !
410 PRINT "PROGRAM COMPLETED"
420 END

```

- Comments**
1. You need to set the Calibration Factor to the correct value for the frequency of the signal you want to measure (line 180).
 2. You need to enable 2 different levels of correction; the global correction (line 270) and duty cycle correction (line 240).
 3. Pulse power averages out any aberrations in the pulse such as overshoot or ringing. For this reason it is called pulse power and not peak power or peak pulse power.
 4. In order to ensure accurate pulse power readings, the input signal must be pulsed with a rectangular pulse. Other pulse shapes (such as triangle, chirp or Gaussian) will cause erroneous results.

Using the Power Meter with the HP 11722A Power Sensor

This section describes how to use the Power Meter to control the HP 11722A Power Sensor.

The HP 11722A Power Sensor has an internal relay which can be controlled by the Power Meter. This allows you to switch between two signal paths. This feature can be useful in ATE applications where you may want to measure two different parameters of a signal, for example power and frequency, without having to disconnect cables. An example set-up is show in Figure 3-6.

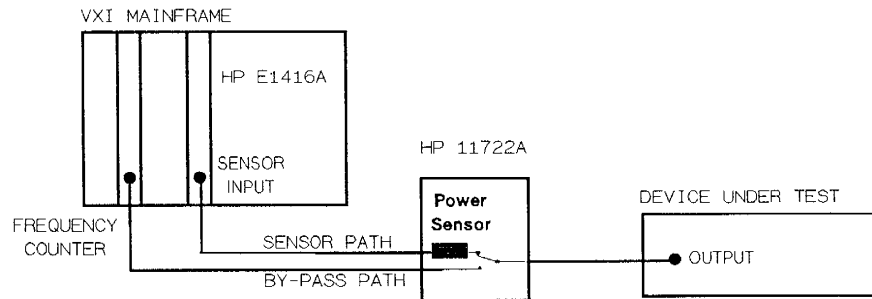

Figure 3-6. Using the HP 11722A Power Sensor

Controlling the Power Sensor

The Power Sensor can be controlled using the following commands:

- INPut[:STATe]
- CONFigure, MEASure, [:SENSE]:FUNCtion

INPut[:STATe]

Use this command if you only want to change the routing of the signal. The commands to control the routing are:

```
INPut[:STATe] ON|1      Routes the signal to the Power Meter
INPut[:STATe] OFF|0    Routes the signal to the By-Pass Path
```

You can find out the status of the routing by using the following command:

```
INPut[:STATe]?        Query the Power Meter
enter statement        Enter the result into the computer
```

If the result is 1 the signal is routed to the Power Meter, if the result is 0 the signal is routed to the By-Pass path.

CONFigure, MEASure, [:SENSE]:FUNCtion

These commands automatically route the signal to the Power Meter. For example the command

```
MEASure:POWer:AC?
```

prepares the Power Meter for making a power measurement, sets INPut:STATe to ON, then makes the power measurement. For more

information about these commands refer to *Chapter 4 - Command Reference*.

Note



After a *RST or SYSTem:PRESet, the INPut:STATe is set to ON (Sensor path selected).

Triggering the Power Meter

The trigger configuration is automatically set by the MEASURE command. If you want to use the lower level commands (READ? or INITiate), then you need to understand the Power Meter's trigger model.

The TRIGGER commands are used to synchronize Power Meter actions with specified events. Figure 3-7 summarizes the Power Meter's trigger system.

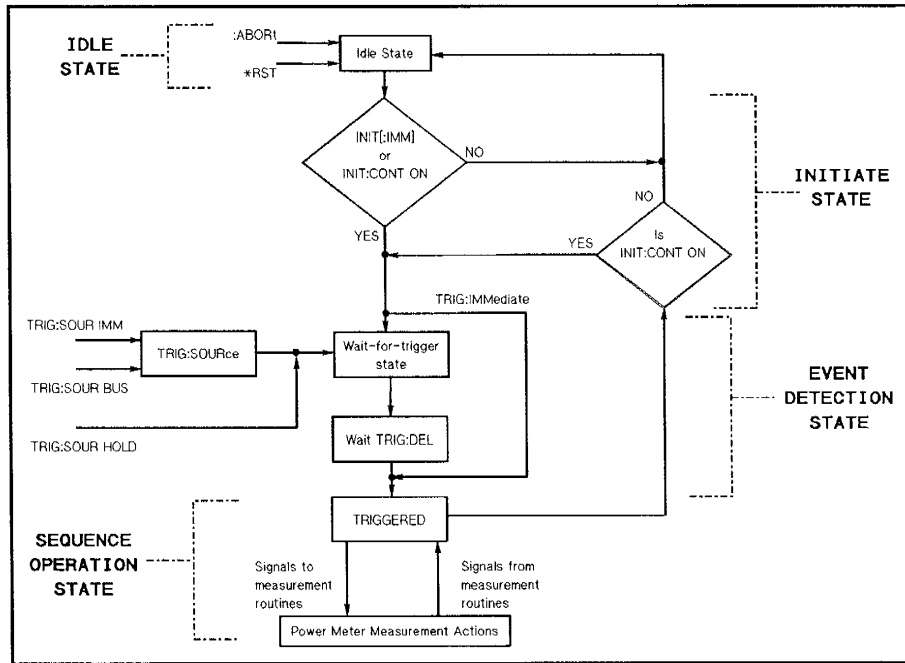

Figure 3-7. Trigger System

The Idle State

Turning power on, sending an HP-IB CLEAR, sending a *RST or an :ABORT forces the trigger system into the idle state. The trigger system remains in the IDLE state until it is initiated by INITiate:CONTinuous ON or INITiate:IMMEDIATE. Once one of these conditions is satisfied the trigger system moves to the initiate state.

The Initiate State

If the trigger system is on the downward path, it travels directly through the initiate state without any restrictions. If the trigger system is on the upward path, and INITiate:CONTinuous is ON, it exits downward to the event detection state. If the trigger system is on the upward path and INITiate:CONTinuous is OFF, it exits upwards to the idle state.

The Event Detection State

The trigger source specifies which event causes the trigger system to travel through the event detection state. The trigger source is set with the following command:

```
TRIGger:SOURce
```

There are three possible trigger sources.

- **IMMEDIATE:** if this command is sent, the Power Meter does not wait for any event and immediately travels through the event detection state.
- **HOLD:** this command suspends triggering. The only way to trigger the Power Meter when TRIG:SOUR HOLD is set is to send TRIG:SOUR IMM.
- **BUS:** trigger source is the HP-IB group execute trigger (<GET>) or a *TRG command. <GET> can be sent using the TRIGGER command in HP BASIC.

Querying the Trigger Source

The trigger source is queried with the following command:

```
TRIGger:SOURce?
```

Trigger Delay

The Power Meter has the ability to insert a delay between receiving a trigger and making the measurement. The delay is automatically calculated by the Power Meter and depends on the current range, resolution and filter length. The delay ensures that the analog circuitry in the Power Meter has settled.

To enable the delay, use the following command:

```
TRIGger:DELAy:AUTO ON
```

To disable the delay, use the following command:

```
TRIGger:DELAy:AUTO OFF
```

Note



MEASure and CONFIgure automatically enable the delay.

Status Reporting

Status Reporting is used to monitor the Power Meter to determine when events have occurred. This allows you to increase the efficiency of your programs. Status reporting is accomplished by configuring and reading status registers. The Power Meter has the following registers:

- Status Register
- Standard Event Register
- Operation Status Register
- Questionable Status Register

You read and configure the Status and Standard Event register using IEEE 488.2 Common commands. These are the most commonly used registers and are discussed in detail in this section.

You read and configure the Operation Status Register and the Questionable Status Register using the TMSL STATUS command subsystem. This section contains an overview of these registers. For more detailed information you should refer to *Chapter 4 - Command Reference*.

General Status Register Model

The generalized status register model shown in Figure 3-8 is the building block of the TMSL status system. This model consists of a condition register, a transition filter, an event register and an enable register. A set of these registers is called a *status group*.

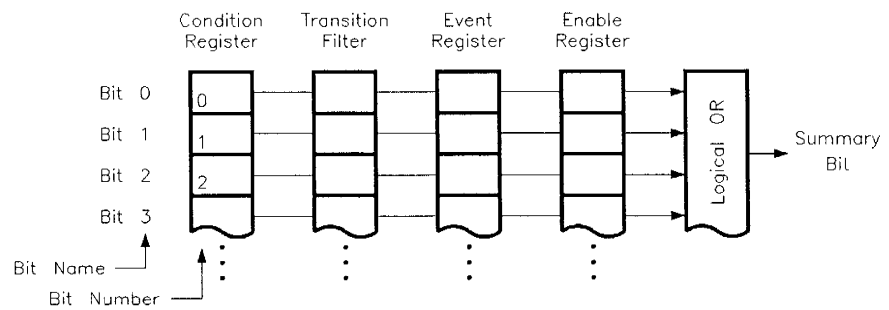

Figure 3-8. Generalized Status Register Model

When a status group is implemented in an instrument, it always contains all of the component registers. However, there is *not* always a corresponding command to read or write to every register.

Condition Register

The *condition register* continuously monitors the hardware and firmware status of the instrument. There is no latching or buffering for this register, it is updated in real time. Condition registers are read-only.

There may or may not be a command to read a particular condition register.

Transition Filter

The *transition filter* specifies which types of bit state changes in the condition register will set corresponding bits in the event register. Transition filter bits may be set for positive transitions (PTR), negative transitions (NTR), or both. Positive means a condition bit changes from 0 to 1. Negative means a condition bit changes from 1 to 0. Transition filters are read-write. Transition filters are unaffected by *CLS (clear status) or queries. After STATUS:PRESet the NTR register is set to 0, and all bits of the PTR are set to 1.

Event Register

The *event register* latches transition events from the condition register, as specified by the transition filter. Bits in the event register are latched, and once set they remain set until cleared by a query or a *CLS (clear status). There is no buffering, so while an event bit is set, subsequent events corresponding to that bit are ignored until the register contents are read and another event occurs. Event registers are read-only.

Enable Register

The *enable register* specifies the bits in the event register that can generate a summary bit. The instrument logically ANDs corresponding bits in the event and enable registers, and ORs all the resulting bits to obtain a summary bit. Summary bits are in turn recorded in the Status Byte. Enable registers are read-write. Querying an enable register does not affect it. There is always a command to read and write to the enable register of a particular status group.

An Example Sequence

Figure 3-9 illustrates the response of a single bit position in a typical status group for various settings. The changing state of the condition in question is shown at the bottom of the figure. A small binary table shows the state of the chosen bit in each status register at the selected times T1 to T5.

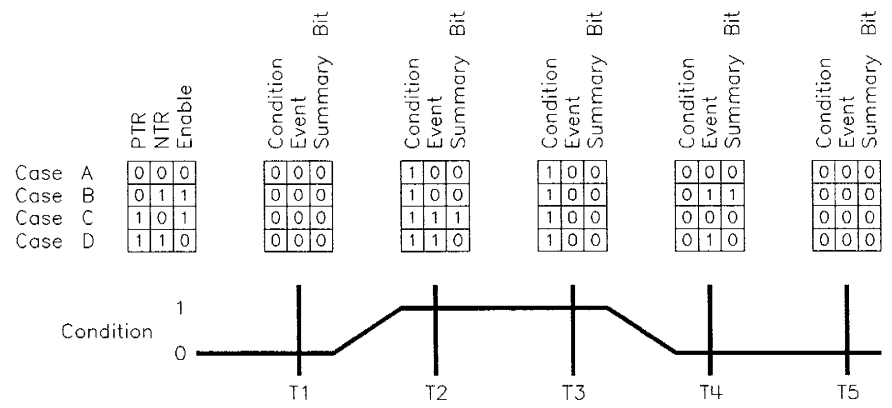

Figure 3-9. Typical Status Register Bit Changes

The Status Register

As shown in Figure 3-10, the Status Register is the highest level register in the status structure and contains bits that report activity from the other status registers.

Note



The bits in the other registers must be specifically enabled to be reported in the Status Register. Refer to the rest of this section for more information.

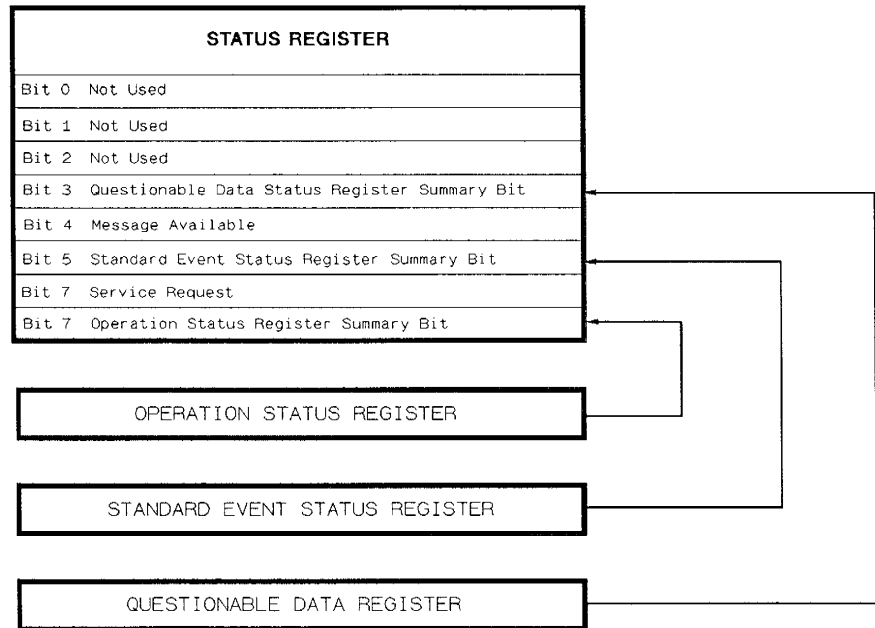

Figure 3-10. Status Structure

Table 3-1 shows each of the Status Register bits and describes the event that will set each bit.

Table 3-1. Status Register

Bit Number	Decimal Weight	Description
0	1	Not Used
1	2	Not Used
2	4	Not Used
3	8	Questionable Status Register Summary Bit. One or more events in the Questionable Status Register have occurred and set bit(s) in that register.
4	16	Message Available. The Power Meter's output queue contains information. This bit can be used to synchronize data exchange with the computer. For example you can send a query command to the Power Meter and then wait for this bit to be set. The HP-IB is then available for use by other devices while the program is waiting for the Power Meter to respond.
5	32	Standard Event Status Register Summary Bit. One or more events in the Standard Event Register have occurred and set bit(s) in that register.
6	64	Service Request. Service has been requested by the Power Meter and the HP-IB SRQ line is set true. This bit will be set true when any other bit of the Status Register is set and has been enabled to assert SRQ by the *SRE command.
7	128	Operation Status Register Summary Bit. One or more events in the Operation Status Register have occurred and set bit(s) in that register.

Reading the Status Register

You read the Status Register using the *STB? command or an HP-IB serial poll. Both methods return the decimal weighted sum of all set bits in the register. The only difference between the two methods is that *STB? does not clear bit 6 (Service request); a serial poll does clear bit 6. No other status register bits are cleared by either method with the exception of the Message Available bit (bit 4) which may be cleared as a result of reading the response to *STB?

The following program uses the *STB? command to read the contents of the Power Meter's Status Register.

```

*STB?                               Read Status Register
  enter statement                    Enter the weighted sum
  print statement                     Print the result

```

For example, assume bit 3 (weight = 8) and bit 7 (weight = 128) are set. The program returns the sum of the two weights (136).

The next program uses the HP-IB Serial Poll to read the Power Meter's Status Register.

```
P=SPOLL(70907)           Read Status Register using Serial Poll,
                          place weighted sum in P
print statement          Print the result
```

Standard Event Status Register

The Standard Event Status Register monitors the Power Meter's status events shown in Table 3-2. When one of these events occurs, it sets a corresponding bit in the Standard Event Status Register.

Note



The Standard Event Status Register bits are not reported in the Status Register unless specifically enabled. Refer to the rest of this section for more information.

Table 3-2. Standard Event Status Register

Bit Number	Decimal Weight	Description
0	1	Operation Complete. The Power Meter has completed all pending operations. This bit is set in response to the *OPC command.
1	2	Not Used
2	4	Query Error. A problem has occurred in the Power Meter's output queue.
3	8	Device Dependent Error. A Power Meter operation did not complete. Possibly due to an abnormal hardware or firmware condition. (usually if *TST fails or the battery fails).
4	16	Execution Error. The Power Meter cannot do the operation(s) requested by a command.
5	32	Command Error. The Power Meter cannot understand or execute the command.
6	64	Not Used
7	128	Power-On. The Power Meter has been switched on.
8—15		Reserved for future use (always return zero).

Enabling Standard Event Status Bits

To allow any of the Standard Event Status Register bits to be reflected in bit 5 of the status register, you have to enable the bit(s) with the *ESE command. For example, suppose your application requires an interrupt whenever any type of error occurs. The error related bits in the Event Status Register are bits 2 through 5. The sum of the decimal weights is 60. You enable these bits to set bit 5 in the Status Register (and assert SRQ if this is enabled) by sending:

```
*ESE 60
```

Whenever an error occurs, it will set one or more of bits 2-5 in the Standard Event Status Register which will set bit 5 in the Status Register. If bit 5 is enabled to assert SRQ (*SRE 32 command) an HP-IB service request is generated. The Standard Event Status Register bits which are not enabled still respond to their corresponding conditions. They do not, however, set bit 5 in the Status Register.

Note



You can read the Standard Event Status Register using the *ESR? command. You can determine which bits are enabled in the Standard Event Status Register using *ESE?. Both of these commands return the decimal weighted sum of all set or enabled bits.

Clearing Status

The *CLS command clears the Standard Event, the Questionable and the Operation Event status registers and the Power Meter's error queue. This clears the corresponding summary bits (3, 5 and 7) and the instrument specific bits (0, 1 and 2) in the Status Register. *CLS does not affect which bits are enabled to be reflected in the Status Register or enabled to assert SRQ.

Interrupting Your Program

When a bit of the Status Register is set and has been enabled to assert SRQ (*SRE command), the Power Meter sets the HP-IB SRQ line true. This interrupt can be used to interrupt your program to suspend its current operation and find out what service the Power Meter requires. (Refer to your computer and language manuals for information on how to program the computer to respond to the interrupt).

To allow any of the Status Register bits to set the SRQ line true, you have to enable the appropriate bit(s) with the *SRE command. For example, suppose your application requires an interrupt whenever a message is available in the output queue (Status Register bit 4, decimal weight 16). To enable bit 4 to assert SRQ, you use the following command:

```
*SRE 16
```

Note

You can determine which bits are enabled in the Status Register using *SRE?. This command returns the decimal weighted sum of all enabled bits

Example This program can be used to cause an SRQ whenever an error occurs.

```
10 ! Program to generate an SRQ when an error occurs
20 ASSIGN @Power TO 70907
30 ! On interrupt at Select Code 7 goto Srq_i
40 ON INTR 7 GOTO Srq_i
50 !Set the Power Meter to make continuous measurements
60 OUTPUT @Power;"*CLS;*RST"
70 !Use logarithmic units
80 OUTPUT @Power;"UNIT:POWer DBM"
90 !
100 PRINT "Set range calibrator to standby and press continue ... "
110 PAUSE
120 OUTPUT @Power;"CAL:ZERO:AUTO ONCE;*OPC?"
130 ENTER @Power;Finished
140 IF Finished=1 THEN PRINT "Zeroing has completed"
150 ! ASSUME THAT ZERO WAS OK
160 PRINT "Set range calibrator to 1mW ... "
165 PRINT "Set function to calibrate"
170 PAUSE
180 OUTPUT @Power;"CAL:AUTO ONCE;*OPC?"
190 ENTER @Power;Finished
200 IF Finished=1 THEN PRINT "Calibration has completed"
210 OUTPUT @Power;"INIT:CONT ON"
220 !Make a power measurement
230 PRINT "Take a power measurement using FETCh? ... "
240 OUTPUT @Power;"FETC?"
250 ENTER @Power;Reading
260 PRINT "The result taken was ";Reading;" dBm."
270 !Now cause an SRQ by removing the power sensor
280 OUTPUT @Power;"*ESE 16"
290 OUTPUT @Power;"*SRE 32"
300 ENABLE INTR 7;2
310 !
320 PRINT "Remove the sensor and an SRQ should occur."
330 !
340 LOOP
350 !wait forever
360 END LOOP
370 STOP
380 !
390 Srq_i: !
400 DIM Message$[256]
410 DISABLE INTR 7
420 CLEAR 7
```

```

430     B=SPOLL(@Power)
440     PRINT "Value received by serial poll was ";B
450     REPEAT
460         OUTPUT @Power;":SYST:ERR?"
470         ENTER @Power;Code,Message$
480         PRINT Code,Message$
490     UNTIL Code=0
500     OUTPUT @Power;"*CLS"
510     END

```

Example 2 This program illustrates how you can use SRQ to track limit failures.

```

10     ! PROGRAM TO DETECT UPPER LIMIT FAILURE USING SRQ
20     ASSIGN @Power TO 70907
30     ! WHEN AN SRQ AT SELECT CODE 7 OCCURS CALL INTERRUPT ROUTINE
40     ON INTR 7 GOSUB Srq_i
50     ! FIRST SETUP THE POWER METER TO TAKE CONTINUOUS READINGS
60     OUTPUT @Power;"*CLS;*RST"
70     ! LET'S USE LOGARITHMIC UNITS
80     OUTPUT @Power;"UNIT:POWer dBm"
90     !
100    PRINT "Set range calibrator to STANDBY and press CONTINUE ... "
110    PAUSE
120    OUTPUT @Power;"CAL:ZERO:AUTO ONCE;*OPC?"
130    ENTER @Power;Finished
140    IF Finished=1 THEN PRINT "Zeroing has completed"
150    ! ASSUME THAT ZERO WAS OK
160    PRINT "Set range calibrator to 1mW and select CALIBRATE.
Press CONTINUE ... "
170    PAUSE
180    OUTPUT @Power;"CAL:AUTO ONCE;*OPC?"
190    ENTER @Power;Finished
200    IF Finished=1 THEN PRINT "Calibration has completed"
210    OUTPUT @Power;"INIT:CONT ON"
220    ! Now let's make a power measurement
230    PRINT "Let's take a power measurement using FETCh? ... "
240    OUTPUT @Power;"FETC?"
250    ENTER @Power;Reading
260    PRINT "The reading taken was ";Reading;" dBm."
270    ! Now let's set up for upper limit failure
280    OUTPUT @Power;"CALC:LIM:UPP 10DBM"
290    PRINT "Upper limit was set to 10dBm"
300    OUTPUT @Power;"CALC:LIM:STAT ON"
310    OUTPUT @Power;"STAT:OPER:PTR 4096"
320    OUTPUT @Power;"STAT:OPER:ENAB 4096"
330    OUTPUT @Power;"*CLS"
340    OUTPUT @Power;"*SRE 128"
350    ENABLE INTR 7;2
360    !
370    PRINT "Change the range calibrator above 10dBm and power

```

```

meter will SRQ"
380  !
390  LOOP
400      ! LET'S LOOP FOREVER - AWAITING SRQ
410  END LOOP
420  STOP
430  !
440 Srq_i:  !
450      DIM Message$[256]
460      DISABLE INTR 7
470      CLEAR @Power
480      B=SPOLL(@Power)
490      PRINT "Value received by serial poll was ";B
500      REPEAT
510          OUTPUT @Power;":SYST:ERR?"
520          ENTER @Power;Code,Message$
530          PRINT Code,Message$
540      UNTIL Code=0
550      !
560      ! CLEAR THE EVENT WHICH CAUSED THE SRQ
570      OUTPUT @Power;"*CLS"
580      ENABLE INTR 7;2
590  RETURN
600  END

```

Using the Operation Complete Commands

The *OPC? and OPC commands allow you to maintain synchronization between the computer and the Power Meter. The *OPC? query command places an ASCII character 1 into the Power Meter's output queue when all pending Power Meter commands are complete. If your program reads this response before continuing program execution, you can ensure synchronization between one or more instruments and the computer.

The *OPC command sets bit 0 (Operation Complete) in the Standard Event Status Register when all pending Power Meter operations are complete. By enabling this bit to be reflected in the Status Register, you can ensure synchronization using the HP-IB serial poll.

Examples

Example 1 This program uses the *OPC? command to determine when the Power Meter has finished calibrating.

```

10 ASSIGN @Power TO 70907
20 OUTPUT @Power;"CAL:AUTO ONCE;*OPC?"
30 ENTER @Power;A
40 OUTPUT @Power;"MEAS:POW:AC?"
50 ENTER @Power;Result
60 PRINT Result

```

70 END

Example 2 This program uses the *OPC command and serial poll to determine when the Power Meter has finished calibrating. The advantage to using this method over the *OPC? command is that the computer can perform other operations while it is waiting for the Power Meter to finish calibrating.

```
10 ASSIGN @Power TO 70907
20 OUTPUT @Power;"*CLS"
30 OUTPUT @Power;"*ESE 1"
40 OUTPUT @Power;"CAL:AUTO ONCE;*OPC"
50 WHILE NOT BIT(SPOLL(@Power),5)
60 !(Computer does other operations here)
70 END WHILE
80 OUTPUT @Power;"MEAS:POW:AC?"
90 ENTER @Power;Result
100 PRINT Result
110 END
```

Saving and Recalling Power Meter Configurations

To reduce repeated programming, up to 10 Power Meter configurations can be stored in the Power Meter's non-volatile memory. All configuration parameters are saved except for the STATUS information and the *<table_name>* being used if the Data Table system is enabled.

How to Save and Recall a Configuration

Power Meter configurations are saved and recalled with the following commands:

```
*SAV <register>  
*RCL <register>
```

The range of values for *register* is 1 to 10.

Example Program

```
10 ASSIGN @Power TO 70907  
20 !Configure the Power Meter  
30 OUTPUT @Power;"CAL:RCF 98PCT;CFAC 98PCT"  
40 OUTPUT @Power;"UNIT:POW DBM"  
50 OUTPUT @Power;"CORR:LOSS -10"  
60 OUTPUT @Power;"CORR:LOSS:STAT ON"  
70 OUTPUT @Power;"CORR:STAT ON"  
80 !Save the configuration  
90 OUTPUT @Power;"*SAV 5"  
95 PRINT "Configuration Saved"  
100 !Now reset the Power Meter  
120 OUTPUT @Power;"*RST"  
130 !Recall the configuration  
140 OUTPUT @Power;"*RCL 5"  
150 PRINT "Configuration Recalled"  
160 PRINT "Save and Recall complete"  
170 END
```

Command Reference

About This Chapter

This chapter describes Test and Measurement System Language (TMSL) commands and summarizes IEEE 488.2 (*) common commands, applicable to the HP E1416A VXI Power Meter. This chapter contains the following sections:

- Command Types 4-1
- TMSL Command Reference 4-4
- IEEE 488.2 Common Command Reference 4-93

Command Types

Commands are separated into two types: IEEE 488.2 Common Commands and TMSL Commands.

Common Command Format

The IEEE 488.2 standard defines the Common commands that perform universal functions such as reset, self-test, status byte query etc. Common commands are always four or five characters in length, always begin with the asterisk (*) character, and may include one or more parameters. The command keyword is separated from the first parameter by a space character. Some examples of Common commands are:

*RST, *STB?, *ESR?

TMSL Command Format

The TMSL commands perform functions for making measurements and retrieving results. The command subsystem structure is hierarchical, usually consisting of a top (root) level command, with one or more low level commands and their parameters. The following example shows a typical subsystem:

```
:AVERage
  [:STATe]
  :COUNT
    AUTO ON|OFF
  TYPE
  TCONtrol?
```

AVERage is the root command, STATe, COUNT, TYPE and TCONtrol? are secondary level commands and AUTO is a third level

command. The precise syntax for these commands and others, is given later in this chapter.

Command Separator

A colon (:) always separates one command from the next lower level command as shown below:

```
:AVERAge:COUNT:AUTO ON
```

Abbreviated Commands

The command syntax shows most commands as a mixture of upper and lower case letters. The upper case letters indicate the abbreviated spelling for the command. For shorter program lines, send the abbreviated form. For better program readability, you may send the entire command. The instrument will accept either the abbreviated form or the entire command.

For example, if the command syntax shows MEASure, then MEAS and MEASURE are both acceptable forms. Other forms of MEASure, such as MEASU or MEASUR will generate an error. You may use upper or lower case letters. Therefore, MEASURE, measure, and MeAsUrE are all acceptable.

Implied Commands

Implied commands are those which appear in square brackets ([]) in the command syntax. (Note that the brackets are not part of the command and are not sent to the instrument.) Suppose you send a second level command but do not send the preceding implied command. In this case, the instrument assumes you intend to use the implied command and it responds as if you had sent it. Examine the partial SENSE subsystem shown below:

```
[[:SENSE]
:POWer
RESolution <res_n>
```

The root command SENSE is an implied command. To enter a resolution into the Power Meter, you can send either of the following command statements:

```
SENSE:POWer:RESolution res_n
POWer:RESolution res_n
```

Parameters

Parameter types. The following table contains explanations and examples of parameter types which might be encountered later on in this chapter.

Parameter Type	Explanations and Examples
Numeric	Accepts all commonly used decimal representations of numbers including optional signs, decimal points, and scientific notation. 123, 123E2, -123, -1.23E2, .123, 1.23E-2, 1.23000E-01. Special cases include DEFault, MINimum, and MAXimum.
Boolean	Represents a single binary condition that is either true or false, parameters are ON OFF or 1 0 (1 and ON are synonymous).
Event	Identifies a command which has no parameter
Discrete	Selects from a finite number of values. These parameters use mnemonics to represent each valid setting. An example is TRIGger:SOURce <source> command, where <i>source</i> could be BUS, HOLD or IMMEDIATE.

Linking Commands **Linking IEEE 488.2 Common Commands with TMSL Commands.**
Use a semicolon between commands. For example:

```
*RST;CAL:CSET:STATe ON
```

Linking Multiple TMSL Commands. Use both a semicolon and a colon between commands. For example:

```
CAL:CSET:STATe ON;:CAL:ALL?
```

After the semi-colon, use the colon to return to the root level, or the system will assume the second command is in the same subsystem.

Responses to TMSL Numeric Query Commands

Many of the TMSL commands which set numeric values within the Power Meter have query forms which allow you to interrogate the setting. A special numeric response, +9.9100E+37, is reserved by TMSL and is known as Not-a-Number (NAN). When this value is returned, you should refer to the command in this chapter which caused the response for more information.

TMSL Command Reference

This section describes the Test and Measurement System Language (TMSL) commands for the HP E1416A VXI Power Meter. Figure 4-1 shows the TMSL command tree structure. Use this to locate the subsystem you are interested in.

:	
	ABORt Page 4-6
	AVERAge Page 4-7
	CALCulate Page 4-11
	CALibration Page 4-21
	CONFigure Page 4-31
	FETCh? Page 4-35
	INITiate Page 4-36
	INPut Page 4-39
	MEASure? Page 4-41
	MEMory Page 4-44
	OUTPut Page 4-56
	READ? Page 4-57
	SENSe Page 4-58
	STATus Page 4-76
	SYSTem Page 4-84
	TRIGger Page 4-88
	UNIT Page 4-92

Figure 4-1. TMSL Command Index

ABORt

The **ABORt** command subsystem removes the Power Meter from the wait-for-trigger state and places it in the idle state.

Subsystem Syntax

ABORt

Comments

- **ABORt** does not affect any other settings of the trigger system. When the **INITiate** command is sent, the trigger system will respond as it did before **ABORt** was executed.
- If **INITiate:CONTinuous ON|1**, then after **ABORt** the Power Meter will immediately move into the wait-for-trigger state.
- When **TRIGger:SOURce BUS** is selected, **ABORt** returns the Power Meter to the idle state. When a **Group Execute Trigger <GET>** bus command or a ***TRG** command is executed, error -211, “Trigger Ignored” occurs.
- When **TRIGger:SOURce HOLD** is selected, **ABORt** returns the Power Meter to the idle state. All subsequent single triggers sent using **TRIGger:IMMediate** are ignored and error - 211, “Trigger Ignored” occurs.s
- When the trigger system is initiated from the HP-IB Interface, execute the **HP-IB CLEAR** command to return to the idle state.
- ***RST Condition:** after a ***RST**, the Power Meter acts as though an **ABORt** has occurred.

Example

To abort a measurement

<code>CONF:POW:AC AUTO,0.01DB</code>	<i>Configure the Power Meter for autorange and 0.01 dB resolution</i>
<code>TRIG:SOUR BUS</code>	<i>Wait for *TRG or <GET></i>
<code>INIT</code>	<i>Put Power Meter in wait-for-trigger state</i>
<code>ABOR</code>	<i>Put Power Meter in IDLE state</i>

AVERage

The AVERage command subsystem is used to control the Power Meter’s digital filter. The digital filter is used to reduce noise, obtain the desired resolution, and temper jitter in the results.

Subsystem Syntax

```
AVERage
[:STATe] ON|1
[:STATe]?
:COUNT <filter_length>
:COUNT?
:AUTO <mode>
:AUTO?
:TYPE SCALar|DEFault
:TYPE?
:TCONtrol?
```

AVER:STAT

AVERage[:STATe] ON|1 indicates that digital filtering is always used. The query command AVERage[:STATe]? always returns 1.

AVER:COUN

AVERage:COUNT <filter_length> is used to enter a value for the filter length, when AVER:COUN:AUTO is set to OFF|0.

Parameter Name	Parameter Type	Range of Values	Default Units
<i>filter_length</i>	numeric	1—1024 DEF MIN MAX	None

Comments

- Specifying this command disables automatic filter length selection (AVER:COUN:AUTO OFF).
- DEF sets *filter_length* to 256.
- MIN sets *filter_length* to 1.
- MAX sets *filter_length* to 1024.
- If a numeric parameter is specified which is not a binary multiple, the Power Meter rounds the value of *filter_length* to the nearest power of 2 within the range allowed. For example if you specify AVER:COUN 5, the Power Meter sets the value of *filter_length* to 4. If you specify AVER:COUN 7, the Power Meter sets the value of *filter_length* to 8.

AVERage Subsystem

- Increasing the value of *filter_length* increases measurement accuracy. However, the time taken to make a power measurement is increased.
- ***RST Condition:** the value of *filter_length* is set to 4.

AVER:COUN?

AVERage:COUNT? [DEF|MIN|MAX] returns one of the following numbers to the output buffer:

- +256 if DEF is specified.
- +1 if MIN is specified.
- +1024 if MAX is specified.
- The current value of *filter_length* if DEF|MAX|MIN is not specified.

AVER:COUN:AUTO

AVERage:COUNT:AUTO <mode> is used to enable or disable auto filtering.

Parameter Name	Parameter Type	Range of Values	Default Units
<i>mode</i>	boolean	OFF 0 ON 1	none

Comments

- If AVER:COUN:AUTO is set to ON|1, auto filter length selection is enabled. In auto filter mode, the Power Meter, automatically sets the number of readings averaged together to satisfy the filtering requirements for most power measurements. The number of readings averaged together depends on the resolution and the power range in which the Power Meter is currently operating in. The following table lists the number of readings averaged for each range and resolution when the Power Meter is in auto filter mode.

	0.1 dBm (1%) Number of Averages	0.01 dBm (0.1%) Number of Averages	0.001 dBm (0.01%) Number of Averages
Range Decade 1	8	128	128
Range Decade 2	1	8	256
Range Decade 3	1	2	32
Range Decade 4	1	1	16
Range Decade 5	1	1	8

- If AVER:COUN:AUTO is set to OFF|0, the filter length is set by the AVER:COUN *filter_length* command. For most applications, AVER:COUN:AUTO ON is the best mode of operation. Manual filter length selection is useful mainly in applications requiring high resolution or fast settling times.
- Auto filtering is enabled by the MEASure:POWer:AC? and CONFigure commands.
- ***RST CONDITION:** AVER:COUN:AUTO is set to ON (auto filter mode enabled).

AVER:COUN:AUTO?

AVERage:COUNT:AUTO? enters 1 or 0 into the output buffer. 1 means that auto filter mode is enabled, 0 means that manual filter length selection is enabled.

AVER:TYPE

AVERage:TYPE SCALar|DEFault indicates that the filter type is arithmetic mean. The query command AVERage:TYPE? always returns SCAL.

AVER:TCON?

AVERage:TCONtrol? (where TCONtrol is the short form of Terminal CONTROL) is used to describe what happens when the filter has been filled and the average has been calculated.

Comments

- If REP is returned, repeat averaging is being used. This means that the filter buffer is cleared each time a new power measurement is taken.
- If MOV is returned, a moving average is being used. This means that the filter buffer is not cleared when a power measurement is taken, and old readings are discarded and replaced by newer readings to return a measurement.
- The averaging mode is selected automatically by the Power Meter depending on the current triggering mode. You cannot specify the averaging mode.
- If INIT:CONT ON and TRIG:SOUR IMM, then the query returns MOV. Otherwise the TCONtrol is REP.

CALCulate

The CALCulate command subsystem provides a limits checking function. This function allows the Power Meter to monitor the power level being measured and to indicate when that power is outside preset limits.

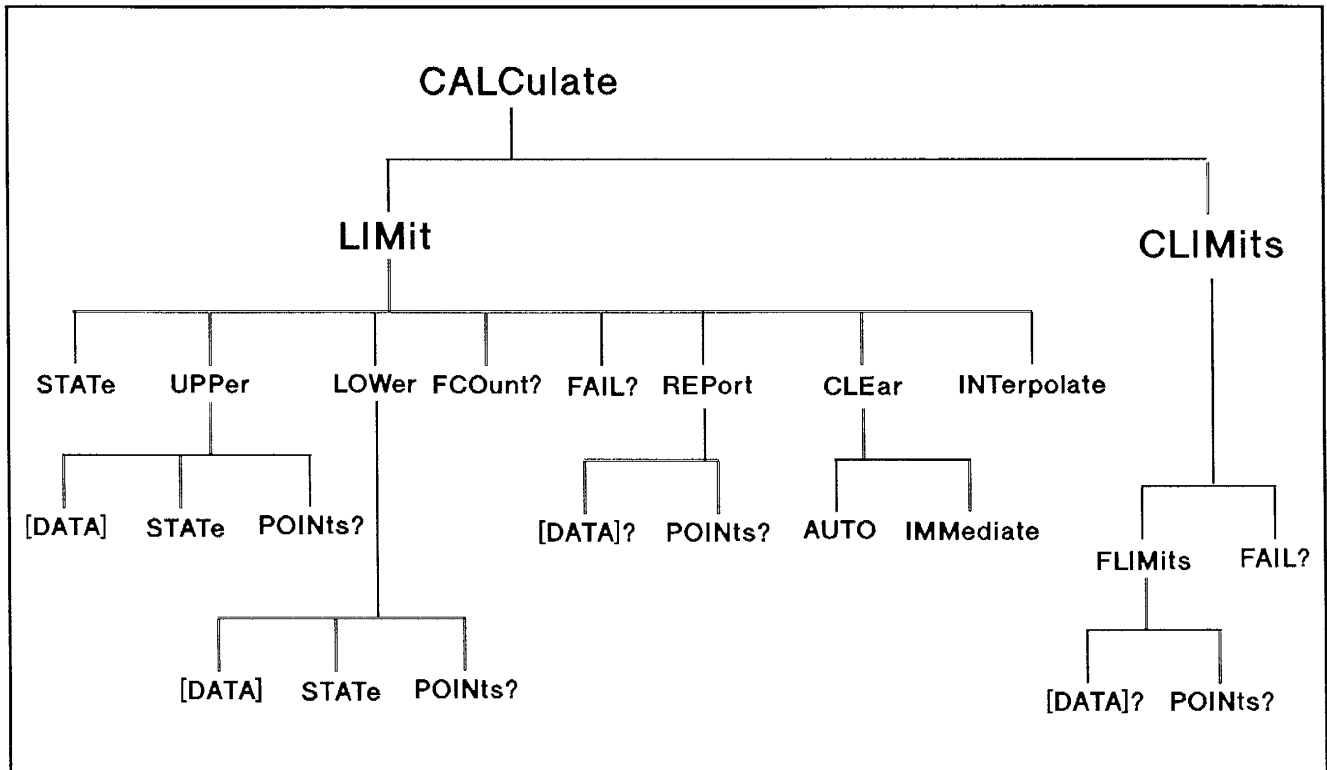

Figure 4-2. CALCulate Subsystem

Subsystem Syntax CALCulate

```

:LIMit
:STATe <mode>
:STATe?
:UPPer
[:DATA] <upper_limit>
[:DATA]?
:POINts?
:STATe <mode>
:STATe?
:LOWer
[:DATA] <lower_limit>
[:DATA]?
:POINts?
:STATe <mode>
:STATe?
:FAIL?
:FCOunt?
:REPort
[:DATA]?
:POINts?
:CLEar
:AUTO <mode>
[:IMMediate]
:INTerpolate <mode>
:INTerpolate?
:CLIMits
:FAIL?
:FLIMits
[:DATA]?
:POINts?
    
```

CALC:LIM:STAT

CALCulate:LIMit:STATe <mode> is the global enable/disable command for the limits checking function.

Parameters

Parameter Name	Parameter Type	Range of Values	Default Units
<i>mode</i>	boolean	OFF 0 ON 1	none

- Comments**
- ON|1 enables limits checking.
 - OFF|0 disables limits checking.
 - The command does not enable UPPER or LOWER limit checking. Use the associated STATE commands to enable/disable checking.
 - ***RST Condition:** CALC:LIM:STAT OFF (limits checking disabled).

Example To enable limits checking

CALC:LIM:STAT ON *Enable limits checking*

CALC:LIM:STAT?

CALCulate:LIMit:STATe? enters 1 or 0 into the output buffer. A response of 1 means that the limits checking feature is enabled, 0 means that the feature is disabled.

CALC:LIM:UPP[:DATA]

CALCulate:LIMit:UPPer[:DATA] <upper_limit> [pow_suffix] is used to enter a value for the upper limit.

Parameters

Parameter Name	Parameter Type	Range of Values (dBm)	Default Units
<i>upper_limit</i>	numeric	−90.000 to +90.000 DEF MIN MAX	Defined by UNIT:POW

- Comments**
- DEF sets the upper limit to +90.000 dBm (1E+06 W).
 - MIN sets the upper limit to −90 dBm (1E−12 W).
 - MAX sets the upper limit to +90.000 dBm (1E+06 W).
 - If *pow_suffix* is omitted, then the units assumed are those set by UNIT:POW.
 - The upper limit can be entered in any units specified by *pow_suffix*.
 - ***RST Condition:** CALC:LIM:UPP is set to +90 dBm (1E+06W)

Example To set the upper limit to −25 dBm

UNIT:POW DBM *Set measurement units to dBm*
 CALC:LIM:UPP −25 *Set the upper limit to −25 dBm*

CALC:LIM:UPP[:DATA]?

CALCulate:LIMit:UPPer[:DATA]? [DEF|MIN|MAX] returns one of the following numbers to the output buffer:

- +90.000 dBm (1E+06 W) if DEF is specified.
 - -90 dBm (1E-12 W) if MIN is specified.
 - +90.000 dBm (1E+06 W) if MAX is specified.
 - The current value of *upper_limit* if DEF|MAX|MIN is omitted.
-

CALC:LIM:UPP:POIN?

CALCulate:LIMit:UPPer:POINts? always returns a value of 1 to the output buffer. This indicates that the number of upper limit points is 1.

CALC:LIM:UPP:STAT

CALCulate:LIMit:UPPer:STATe <mode> is used to enable UPPER limit checking.

Parameters

Parameter Name	Parameter Type	Range of Values	Default Units
<i>mode</i>	boolean	OFF 0 ON 1	none

Comments

- ON|1 enables upper limit checking.
- OFF|0 disables upper limit checking.
- The higher level CALC:LIM:STAT command must be set to ON to enable upper limit checking.
- ***RST Condition:** CALC:LIM:UPP:STAT ON (upper limit checking enabled).

Example

To enable upper limit checking

```
CALC:LIM:STAT ON           Enable limits checking
CALC:LIM:UPP:STAT ON      Enable upper limit checking
```

CALC:LIM:UPP:STAT?

CALCulate:LIMit:UPPer:STATe? enters 1 or 0 into the output buffer. A response of 1 means that upper limit checking is enabled, 0 means that upper limit checking is disabled.

CALC:LIM:LOW[:DATA]

CALCulate:LIMit:LOWer[:DATA] <lower_limit> [*pow_suffix*] is used to enter a value for the LOWER limit.

Parameters

Parameter Name	Parameter Type	Range of Values (dBm)	Default Units
<i>lower_limit</i>	numeric	-90.000 to +90.000 DEF MIN MAX	Defined by UNIT:POW

Comments

- **DEF** sets the lower limit to -90.000 dBm (1E-12 W).
- **MIN** sets the lower limit to -90.000 dBm (1E-12 W).
- **MAX** sets the lower limit to +90.000 dBm (1E+06 W).
- If *pow_suffix* is omitted, then the units assumed are those set by UNIT:POWER.
- The lower limit can be entered in any units specified by *pow_suffix*.
- ***RST Condition:** CALC:LIM:LOW is set to -90 dBm (1E-12W)

Example

To set the lower limit to -55 dBm

UNIT:POW DBM

Set measurement units to dBm

CALC:LIM:LOW -55

Set the lower limit to -55 dBm

CALC:LIM:LOW[:DATA]?

CALCulate:LIMit:LOWer[:DATA]? [DEF|MIN|MAX] returns one of the following numbers to the output buffer:

- -90.000 dBm (1E-12 W) if DEF is specified.
 - -90 dBm (1E-12 W) if MIN is specified.
 - +90.000 dBm (1E+06 W) if MAX is specified.
 - The current value of *lower_limit* if DEF|MAX|MIN is omitted.
-

CALC:LIM:LOW:POIN?

CALCulate:LIMit:LOWer:POINTs returns a value of 1 to the output buffer. This indicates that the number of lower limit points is 1.

CALC:LIM:LOW:STAT

CALCulate:LIMit:LOWer:STATe <mode> is used to enable LOWER limit checking.

Parameters

Parameter Name	Parameter Type	Range of Values	Default Units
<i>mode</i>	boolean	OFF 0 ON 1	none

Comments

- ON|1 enables lower limit checking.
- OFF|0 disables lower limit checking.
- The higher level CALC:LIM:STAT command must be set to ON to enable lower limit checking.
- ***RST Condition:** CALC:LIM:LOW:STAT ON (lower limit checking enabled).

Example

To enable lower limit checking

```
CALC:LIM:STAT ON           Enable limits checking
CALC:LIM:LOW:STAT ON      Enable lower limit checking
```

CALC:LIM:LOW:STAT?

CALCulate:LIMit:LOWer:STATe? enters 1 or 0 into the output buffer. A response of 1 means that lower limit checking is enabled, 0 means that lower limit checking is disabled.

CALC:LIM:FAIL?

CALCulate:LIMit:FAILure? enters 1 or 0 into the output buffer. A response of 1 means that one or more limit failure(s) have occurred, 0 means that no limit failures have occurred.

CALC:LIM:FCO?

CALCulate:LIMit:FCOunt? is used to return the total number of limit failures. If the appropriate STATE commands are set to ON, then each time a measurement is initiated, and the measurement result is outside the limits, the counter is incremented by 1.

Comments

- If the measured value is equal to a limit, this counts as a limit pass.
- The counter can be reset to zero by any of the following commands

```
*RST
CALC:LIM:CLE:IMM
CALC:LIM:CLE:AUTO ON
```

When CALC:LIM:CLE:AUTO ON is set to ON, the counter is set to zero each time INIT[:IMM] or INIT:CONT ON is sent.

- If UPPER and LOWER limit checking are both enabled, use the STATUS commands to find out which limit has failed. See the STATUS subsystem for more information.
- ***RST Condition:** the counter is set to zero.

Example

To find out the number of limit failures

UNIT:POW DBM	<i>Set measurement units to dBm</i>
CALC:LIM:UPP -25	<i>Set the upper limit to -25 dBm</i>
CALC:LIM:CLE:IMM	<i>Clear the counter</i>
MEAS:POW:AC?	<i>Make a power measurement</i>
CALC:LIM:FCO?	<i>Query the Power Meter</i>
enter statement	<i>Enter the result into the computer</i>

CALC:LIM:REP[:DATA]?

CALCulate:LIMit:REPort[:DATA]? enters 1.0000E+00 into the output buffer if there has been one or more limit failures, or +9.9100E+37 if there have been no limit failures.

- Comments**
- The appropriate STATE commands must be set to ON.
 - If UPPER and LOWER limit checking are both enabled, use the STATUS commands to find out which limit has failed. See the STATUS subsystem for more information.
 - ***RST Condition:** the query will return +9.9100E+37 since the number of limit fails will return to zero.

CALC:LIM:REP:POIN?

CALCulate:LIMit:REPort:POINts? enters a 1 into the output buffer if there has been one or more limit failures, or 0 if there have been no limit failures.

- Comments**
- The appropriate STATE commands must be set to ON.
 - If UPPER and LOWER limit checking is enabled, use the STATUS commands to find out which limit has failed. See the STATUS subsystem for more information.

CALC:LIM:CLE:AUTO

CALCulate:LIMit:CLEAr:AUTO <mode> is used to control the accumulation of limit failures.

Parameter Name	Parameter Type	Range of Values	Default Units
<i>mode</i>	boolean	OFF 0 ON 1	none

- Comments**
- If ON|1 is specified, the CALC:LIM:FCO? counter is set to 0 each time a measurement is initiated using INIT[:IMM] or INIT:CONT ON.
 - If OFF|0 is specified, the CALC:LIM:FCO? counter is not cleared each time a measurement is initiated using INIT[:IMM] or INIT:CONT ON.
 - ***RST Condition:** CALC:LIM:CLE:AUTO is set to OFF.

CALC:LIM:CLE:AUTO?

CALCulate:LIMit:CLEar:AUTO? enters 1 or 0 into the output buffer. A response of 1 means that limit failures are cleared when a new measurement is initiated, 0 means that limit failures are not cleared.

CALC:LIM:CLE:IMM

CALCulate:LIMit:CLEar:IMMEDIATE is used to clear the FCO counter to 0.

- The CALC:LIM:FCO? counter is set to 0 and CALC:LIM:CLE is set to OFF.

CALC:LIM:INT

CALCulate:LIMit:INTerpolate <mode> indicates that the Power Meter does not use interpolation, since the Power Meter does not use a vector of upper/lower points. The only legal parameter is OFF|0. The query command CALC:LIM:INT? always returns 0.

CALC:CLIM:FAIL?

CALCulate:CLIMits:FAIL? returns an equivalent response to the CALC:LIM:REP:POIN? command.

CALC:CLIM:FLIM[:DATA]?

CALCulate:CLIMits:FLIMits[:DATA]? returns an equivalent response to the CALC:LIM:REP:DATA? command.

CALC:CLIM:FLIM:POIN?

CALCulate:CLIMits:FLIMits:POINts returns an equivalent response to the CALC:LIM:REP:POIN? command.

CALibration

The **CALibration** command subsystem is used to zero and calibrate the Power Meter and to set the Reference Calibration and Calibration Factors for the Power Sensor being used. The subsystem is illustrated in Figure 4-3.

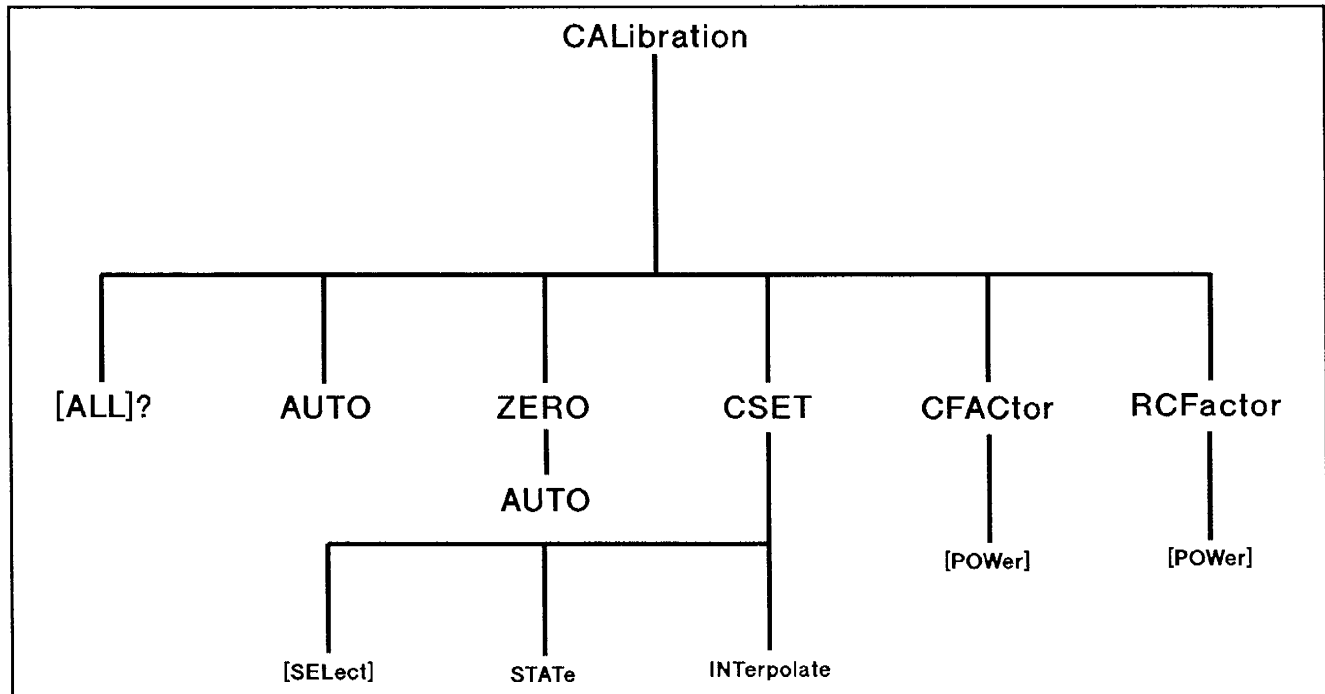

Figure 4-3. CALibration Subsystem

Subsystem Syntax

```

CALibration
  :[ALL]?
  :[ALL]
  :AUTO ONCE
  :AUTO?
  :ZERO
    :AUTO ONCE
    :AUTO?
  :CSET
    [:SElect] <table_name>
    [:SElect]?
    :STATe <mode>
    :STATe?
    :INTerpolate <mode>
    :INTerpolate?
  :CFACtor
    [:POWer] <cal_fac>
    [:POWer]?
  :RCFactor
    [:POWer] <refcal_fac>
    [:POWer]?
  
```

CAL[:ALL]?

CALibration[:ALL]? makes the Power Meter perform a calibration sequence. The calibration sequence consists of:

- Zeroing (CAL:ZERO:AUTO ONCE).
- Calibrating the Power Meter (CAL:AUTO ONCE)

When the calibration sequence is completed, a number is entered into the output buffer to flag if the sequence was successful. If the result is 1, then the calibration has failed.

Comments

- The command assumes that the Power Sensor is connected to the Power Reference output and will turn the Reference Oscillator on, then return it to the same state it was previously in.
- If the sequence fails, the information contained in the error queue will provide more information about the reason for the failure.
- The Reference Calibration Factor used during calibration is determined by the state of CSET:STATE. If CSET:STATE is ON, then the Reference Calibration Factor used is the value stored in the currently active Data Table (use CAL:RCF? to find out the value being used). If CSET:STATE is OFF, then the Reference Calibration Factor used is the value you enter using CAL:RCF.
- Zeroing and calibration of the Power Meter is recommended:
 1. When a 5° change in temperature occurs.
 2. When you change the Power Sensor being used.
 3. Every 24 hours.

Example

To perform a Power Meter calibration sequence

CAL:ALL?
 enter statement

Perform a calibration sequence
Check if the sequence was successful

Related Commands

OUTPut:ROSC

CAL[:ALL]

CALibration:[ALL] is an alternate form of **CALibration:[ALL]?**. The only difference between the commands is that **CAL [:ALL]** does not return a number to the output buffer.

CAL:AUTO ONCE

CALibration:AUTO ONCE calibrates the Power Meter.

Comments

- The command assumes that the Power Sensor is connected to the Power Reference output.
- The Reference Calibration Factor used during calibration is determined by the state of **CSET:STATe**. If **CSET:STATe** is ON, then the Reference Calibration Factor used is the value stored in the currently active Data Table (use **CAL:RCF?** to find out the value being used). If **CSET:STATe** is OFF, then the Reference Calibration Factor used is the value you enter using **CAL:RCF**.
- The Power Meter should be zeroed before calibration.
- Zeroing and calibration of the Power Meter is recommended:
 1. When a 5° change in temperature occurs.
 2. When you change the Power Sensor being used.
 3. Every 24 hours.

Example

To calibrate the Power Meter

CAL:AUTO ONCE	<i>Calibrate the Power Meter</i>
enter statement	<i>Check if the calibration was successful</i>

CAL:AUTO?

CALibration:AUTO? always returns a value of 0 to the output buffer, since the Power Meter does not perform an auto calibration.

Example

To query the Auto Calibration Mode

CAL:AUTO?	<i>Query the Power Meter to return auto calibration mode</i>
enter statement	<i>Enter the value into the computer</i>

CAL:ZERO:AUTO ONCE

CALibration:ZERO:AUTO ONCE makes the Power Meter perform its zeroing routine. This adjusts the Power Meter's internal circuitry for a zero power reading with no power supplied to the Power Sensor.

- Comments**
- The command assumes that the Power Sensor is not connected to a power source. If OUTP:ROSC is ON, then the Power Meter switches it to OFF. After zeroing is completed, the Power Meter sets OUTP back to the same state as before zeroing.
 - Zeroing and calibration of the Power Meter is recommended:
 1. When a 5° change in temperature occurs.
 2. When you change the Power Sensor being used.
 3. Every 24 hours.
 - Zeroing takes approximately 5-30 seconds.

Example **To Zero the Power Meter**
CAL:ZERO:AUTO ONCE *Zero the Power Meter*

Related Commands OUTPut:ROSC

CAL:ZERO:AUTO? **CALibration:ZERO:AUTO?** always returns a value of 0 to the output buffer, since the Power Meter does not perform an auto zero.

Example **To query the Auto Zero Mode**
CAL:ZERO:AUTO? *Query the Power Meter to return auto zero mode*
enter statement *Enter the value into the computer*

CAL:CSET[:SEL]

CALibration:CSET[:SElect] <table_name>|*OPTIONAL*> transfers a Data Table from Editing Space to Measurement Space.

Comments

- If <table_name> is omitted, the Data Table currently active in Editing Space is transferred (*table_name* returned by MEM:SEL?).
- Refer to MEMory Subsystem for information about *table_name*.
- When the table is transferred, the Power Meter checks that the number of Frequency points and Calibration Factor points defined in the table are equal and that a Reference Calibration Factor is present. If there is a mismatch in the number of points, or the Reference Calibration Factor is missing, an error is generated.
- If the <table_name> does not exist in Editing Space, then an error occurs (use MEM:CAT? to list the tables stored in Editing Space).
- The Data Table Reference Calibration Factor and Calibration Factors will only be used when CSET:STATe is ON.
- ***RST Condition:** the Data Table in Measurement Space is not affected.

Example

To transfer a Data Table

CAL:CSET "SENSOR_1"

*Transfer Data Table named
SENSOR_1 from Editing Space to
Measurement Space*

Related Commands

MEMory
[:SENSE]:FREQuency

CAL:CSET[:SEL]?

CALibration:CSET[:SElect]? returns the name of Data Table currently in Measurement Space.

Comments

- If CAL:CSET:STAT is set to OFF, the Data Table is not being used.
- Query returns the *table-name* as a quoted string. For example, after CAL:CSET SENSOR_1, the query CAL:CSET? returns "SENSOR_1"

Example To find out which Data Table is currently in Measurement Space

CAL:CSET? *Query the Power Meter to return name of the Data Table currently in Measurement Space*

enter statement *Enter the Data Table name*

Related Commands MEMory,
[:SENSe]:FREQuency

CAL:CSET:STAT

CALibration:CSET:STATe <mode> is used to enable the Data Table System.

Parameters

Parameter Name	Parameter Type	Range of Values	Default Units
<i>mode</i>	boolean	OFF 0 ON 1	none

Comments

- If there is no Data Table in Measurement Space, then the command will produce an error (CAL:CSET:STAT is left OFF).
- When CAL:CSET:STAT is set to ON, the Reference Calibration Factor associated with the Data Table is used during calibration.
- To use a Calibration Factor stored in the Data Table, specify a frequency parameter using [:SENSe]:FREQuency.
- If a frequency parameter is specified with CONFigure or MEASure, CAL:CSET:STAT is set to ON if a table has been selected in Measurement Space.
- ***RST Condition:** CAL:CSET:STAT is set to OFF (Single Correction System is enabled).

Example To enable the Data Table System

CAL:CSET "SENSOR_1" *Transfer Data Table named SENSOR_1 from Editing Space to Measurement Space*

CAL:CSET:STATe ON *Enable the Data Table System. (Data Table SENSOR_1 is used)*

Related Commands MEMory
[:SENSe]:FREQuency
CONFigure
MEASure?

CAL:CSET:STAT?

CALibration:CSET:STATe? enters 1 or 0 into the output buffer. 1 means that the Data Table System is enabled, 0 means that the Single Correction System is enabled.

Comments

- If the query returns 1, **CONF?** will also return the frequency used to calculate the Calibration Factor.

Example

To check which system is enabled

```
CAL:CSET "SENSOR_1"      Transfer Data Table named
                           SENSOR_1 from Editing Space to
                           Measurement Space

CAL:CSET:STATe ON       Enable the Data Table System
CAL:CSET:STATe?        Query the Power Meter
enter statement         Enter the value into the computer
                           (result is 1)
```

Related Commands

MEMory
CONFigure?

CAL:CSET:INT

CALibration:CSET:INTerpolate <mode> indicates that the Power Meter always uses linear interpolation to calculate a Calibration Factor (when the Data Table System is enabled and a frequency is specified). The only valid parameters are 1|ON. If you try to set **CAL:CSET:INT** to 0|OFF, error -224, "Illegal parameter" occurs.

The command **CALibration:CSET:INTerpolate?** always returns 1.

CAL:CFAC[:POW]

CALibration:CFACtor[:POWer] <cal_fac> [*pct_suffix*] is used to enter a Calibration Factor when the Single Correction Sytem is enabled.

Parameters

Parameter Name	Parameter Type	Range of Values	Default Units
<i>cal_fac</i>	numeric	1.0 to 150.0PCT DEF MIN MAX	PCT

CALibration Subsystem

- Comments**
- **DEF** sets the Calibration Factor to 100%.
 - **MIN** sets the Calibration Factor to 1%.
 - **MAX** sets the Calibration Factor to 150%.
 - **PCT** is the only legal suffix and can be omitted.
 - The Calibration Factor will be used when **CAL:CSET:STAT** is **OFF**.
 - ***RST Condition:** the Calibration Factor is set to 100%.

Example To enter a single Calibration Factor

`CAL:CFAC 98.6` *Enter a calibration factor of 98.6%*

CAL:CFAC[:POW]?

CALibration:CFACtor[:POWer]? [DEF|MIN|MAX] returns one of the following numbers to the output buffer:

- The current Calibration Factor if **DEF|MIN|MAX** is not specified.
- 100.0% if **DEF** is specified.
- 1.0% if **MIN** is specified.
- 150.0% if **MAX** is specified.

- Comments**
- The result is always the value being used to correct the power measurement. If **CAL:CSET:STAT** is **OFF**, the result is from the Single Correction System. If **CAL:CSET:STAT** is **ON**, the result is the value calculated by the Power Meter using linear interpolation.

Example To query the current Calibration Factor

`CAL:CSET:STAT OFF` *Use the Single Correction System*
`CAL:CFAC 98.6` *Enter a calibration factor of 98.6%*
`CAL:CFAC?` *Query the current calibration factor*
`enter statement` *Enter the result into the computer*
(98.6%)

CAL:RCF[:POW]

CALibration:RCFactor[:POWer] <refcal_fac> [pct_suffix] is used to enter a Reference Calibration Factor when the Single Correction System is enabled.

Parameters

Parameter Name	Parameter Type	Range of Values	Default Units
refcal_fac	numeric	50.0 to 120.0PCT DEF MIN MAX	PCT

Comments

- **DEF** sets the Reference Calibration Factor to 100%.
- **MIN** sets the Reference Calibration Factor to 50%.
- **MAX** sets the Reference Calibration Factor to 120%.
- This value is used during CAL[:ALL]?, CAL[:ALL] and CAL:AUTO ONCE if CAL:CSET:STAT is OFF.
- ***RST Condition:** the Reference Calibration Factor is set to 100%.

Example

To enter a Reference Calibration Factor

CAL:RCF 98.6

Enter a Reference Calibration Factor of 98.6%

CAL:RCF[:POW]?

CALibration:CFACTOR[:POWer]? [DEF|MIN|MAX] returns one of the following numbers to the output buffer:

- The current Reference Calibration Factor if DEF|MIN|MAX is not specified.
- 100.0% if DEF is specified.
- 50.0% if MIN is specified.
- 120.0% if MAX is specified.

Comments

- The result is always the value being used to calibrate the Power Meter. If CAL:CSET:STAT is OFF, the result is the Reference Calibration Factor entered using CAL:RCF. If CAL:CSET:STAT is ON, the result is the Reference Calibration Factor from the Data Table currently active in measurement space.

CALibration Subsystem

Example To query the current Reference Calibration Factor

CAL:CSET:STAT OFF	<i>Use the Single Correction System</i>
CAL:RCF 98.6	<i>Enter a Reference Calibration Factor of 98.6%</i>
CAL:RCF?	<i>Query the current Reference Calibration Factor</i>
enter statement	<i>Enter the result into the computer (98.6%)</i>

CONF

The **CONFigure** command configures the Power Meter to perform a power measurement with the given range, resolution and frequency. CONFigure does not make the power measurement after setting the configuration. Use READ? or INIT followed by a FETC? to make the measurement.

Subsystem Syntax

CONFigure[:SCALar]:POWer:AC <conf_parm>
CONFigure?

Note



[:SCALar] is an optional parameter and can be omitted.

CONF:POW:AC

CONFigure:POWer:AC <conf_parm> is used to set the range, resolution and frequency of the Power Meter.

Parameters

There are three optional parameters for *conf_parm*:
<conf_pow_range>, <conf_res_n>, <conf_frequency>
The parameters must appear in the order specified.

Parameter Name	Parameter Type	Range of Values	Default Units
<i>conf_pow_range</i>	numeric	<pow_range> ¹ AUTO DEF	Defined by UNIT:POW
<i>conf_res_n</i>	numeric	<res_n> ² DEF	Defined by UNIT:POW
<i>conf_frequency</i>	numeric	<frequency> ³ DEF	Hz

1. See [:SENS]:POW:RANG[:UPP] for information about the range of values.
2. See [:SENS]:POW:RES for information about the range of values.
3. See [:SENS]:FREQ for information about the range of values.

Note



The mnemonic DEF means DEFault. This is not equivalent to the DEFault parameter used in other command subsystems. See the Comments in this subsystem for more information.

Comments

- The parameter *conf_pow_range* uses the same command parameter as POW:RANG[:UPP] (see the [:SENSe] subsystem for more information). If AUTO is specified, the Power Meter is switched to autoranging (equivalent to POW:RANG:AUTO ON).
- The parameter *conf_res_n* uses the same command parameter as POW:RES (see the [:SENSe] subsystem for more information).
- The parameter *conf_frequency* uses the same command parameter as FREQ (see the [:SENSe] subsystem for more information). If CAL:CSET:SEL? returns a *table_name*, then CAL:CSET:STAT is set to ON (Data Table system enabled).
- If the *conf_frequency* parameter is specified but no table has been selected (CAL:CSET:SEL <*table_name*>), the frequency is updated but CAL:CSET:STAT is left OFF.
- The parameters must be entered in the correct order. If parameters are omitted, they will default from left to right. The parameter DEFault is used as a placeholder. Specifying DEF leaves the parameter value unchanged. For example, if you want to change the frequency, but want to leave the range and resolution unchanged, you would use the following command:

```
CONF:POW:AC DEF,DEF,15MHZ
```

If you use the following command:

```
CONF:POW:AC 15MHZ
```

error -131, "Invalid Suffix" occurs, since the Power Meter was expecting a range parameter value.

- The CONFigure command also does the following:

ABOR	<i>Places the Power Meter in the idle state</i>
INIT:CONT OFF	<i>Sets the Power Meter to make 1 trigger cycle when INIT is sent</i>
TRIG:SOUR IMM	<i>Sets the Power Meter to make the measurement immediately a trigger is received</i>
TRIG:DEL:AUTO ON	<i>Enables automatic delay before making the measurement</i>
INP:STAT ON	<i>Sets the HP 11722A Power Sensor to Sensor Path</i>
AVER:COUN:AUTO ON	<i>Enables automatic filter length selection</i>

- If suffixes are omitted, the units assumed for frequency are Hz. For range and resolution the units assumed are determined by the setting of UNIT:POW.

Example To configure the Power Meter and make a measurement

<pre>CAL:CSET "SENSOR_1" UNIT:POW DBM CONF:POW:AC 20DBM,0.1DB,15MHZ READ? enter statement</pre>	<p><i>Transfer Data Table Sensor_1 from Editing Space to Measurement Space</i></p> <p><i>Set measurement units to dBm</i></p> <p><i>Configure the Power Meter to the 20 dBm range, with a resolution of 0.1 dB, and a frequency of 15 MHz (used to calculate the Calibration Factor for the measurement)</i></p> <p><i>Make the measurement</i></p> <p><i>Enter the result into the computer</i></p>
---	--

CONF?

CONFigure? returns the present configuration of the Power Meter.

Comments

- The configuration is returned as a quoted string in the following format:
“POW:AC <pow_range>,<res_n>”
If CAL:CSET:STAT is ON, then a third parameter <frequency> is returned.
- The value returned for *pow_range* is AUTO, if POW:RANG:AUTO is ON, or a numeric value. The numeric value is the same value returned by POW:RANG[:UPP]?. If UNIT:POW is W, W is appended to the value, and if UNIT:POW is DBM, dBm is appended to the value.
- The value returned for *res_n* is always a numeric value, which is the same value returned by POW:RES?. If UNIT:POW is W, W is appended to the value, and if UNIT:POW is DBM, dB is appended to the value.
- The value returned for frequency is always a numeric value, which is the same value returned by FREQ?. The units are always Hz. This parameter is only returned if :CAL:CSET:STAT is ON.
- The command will track changes made to the parameters by the [:SENSe] and MEASure subsystems.

CONFigure Subsystem

Example To query the configuration of the Power Meter

<code>CAL:CSET "SENSOR_1"</code>	<i>Transfer Data Table Sensor_1 from Editing Space to Measurement Space</i>
<code>UNIT:POW DBM</code>	<i>Set measurement units to dBm</i>
<code>CONF:POW:AC 20DBM,0.1DB,15MHZ</code>	<i>Configure the Power Meter to the 20 dBm range, with a resolution of 0.1 dB, and a frequency of 15 MHz (used to calculate the Calibration Factor for the measurement)</i>
<code>CONF?</code>	<i>Query the Power Meter to return its present configuration</i>
<code>enter statement</code>	<i>Enter the result into the computer</i>

FETC[:POW:AC]?

The **FETCh[:POWer:AC]?** command retrieves the measurement result stored in the Power Meter by the most recent **INITiate** command, and places it in the output buffer. This command is most commonly used with **CONFigure**.

Subsystem Syntax FETCh[:POWer:AC]?

- Comments**
- Execute **INITiate** or **INITiate:CONTinuous ON** to place the Power Meter in the wait-for-trigger state. If **TRIG:SOUR IMM** then use **FETC?** to retrieve the measurement result. If the Power Meter is in the wait-for-trigger state and **TRIG:SOUR** is **HOLD** or **BUS**, error –230, “Data corrupt or stale” will occur if **FETCh?** is issued. When **TRIG:SOUR** is **HOLD**, the Power Meter must be triggered by **TRIG:IMM** or ***TRG**, before **FETCh?** will retrieve the measurement. When **TRIG:SOUR** is **BUS**, the Power Meter must be triggered by **TRIG:IMM**, ***TRG** or **<GET>**, before **FETCh?** will retrieve the measurement.
 - Each reading sent to the output buffer contains 12 bytes (characters) in Real ASCII format:
 $\pm 1.2345 \pm E67LF$
 Each measurement is terminated with a Line Feed (*LF*). The HP-IB End-or-Identify (EOI) signal is sent with the last byte transferred.
 - ***RST Condition:** since ***RST** places the Power Meter in the idle state, executing **FETCh?** after a ***RST**, generates the –230, “Data corrupt or stale” error.

Example To transfer a reading from the Power Meter’s memory to the output buffer

```
CONF:POW:AC DEF,0.1dB,DEF Configure the Power Meter, sets
                           TRIG:SOUR to IMM
INIT Make a power measurement
FETC? Transfer the result from memory to
        the output buffer
enter statement Enter the result into the computer
```

Related Commands

- CONFigure
- INITiate
- READ?

INITiate

The **INITiate** command subsystem places the Power Meter in the wait-for-trigger state. This command is most commonly used with **CONFigure**.

Subsystem Syntax

```
INITiate
    [:IMMediate]
    :CONTInuous <mode>
    :CONTInuous?
```

INIT[:IMM]

INITiate[:IMMediate] places the Power Meter in the wait-for-trigger state. When a trigger is received, the measurement is taken and the result placed in Power Meter memory.

Comments

- After the trigger system is initiated using **INITiate**, use the **TRIGger** command subsystem to control the behaviour of the trigger system.
- If **TRIGger:SOURce** is **IMMediate**, the measurement starts as soon as **INITiate** or **INITiate:CONTInuous ON** is executed.
- If the Power Meter is not in the idle state or **INITiate:CONTInuous** is **ON**, error -213, “INIT ignored” occurs.
- To transfer a measurement result from memory to the output buffer, use the **FETCh?** command.
- If the Power Meter is in the wait-for-trigger state, the **ABORt** command places the Power Meter in its idle state and terminates any measurement in progress.
- The **READ?** command executes **INITiate** implicitly. The **MEASure?** command executes **READ?** implicitly.
- The command sets the pending operation flag true.

Example

To place the Power Meter in the wait-for trigger state

```
CONF:POW:AC DEF,0.1DB,DEF Configure the Power Meter
TRIG:SOUR BUS Set trigger source to BUS (Power
Meter will be triggered by <GET> or
*TRG
INIT Place the Power Meter in
wait-for-trigger state; store the
measurement result in memory when
the trigger is received
*TRG Trigger the Power Meter
FETC? Place the measurement result in the
output buffer
enter statement Enter the result into the computer
```

INIT

*Re-initiate the wait-for-trigger state for next measurement***INIT:CONT**

INITiate:CONTinuous *<mode>* is used to set the Power Meter for either a single trigger cycle or continuous trigger cycles. A trigger cycle means that the Power Meter moves from the Trigger Layer to the Measurement Layer (trigger source is set by TRIG:SOUR command).

Parameters

Parameter Name	Parameter Type	Range of Values	Default Units
<i>mode</i>	boolean	OFF 0 ON 1	none

Comments

- If INIT:CONT is set to OFF, the Power Meter will make one trigger cycle after INIT is sent. After the Power Meter is triggered, the Power Meter will revert back to the IDLE state and the only way a trigger cycle can be started is using the INIT:IMM command.
- If INIT:CONT is set to ON, the Power Meter makes a trigger cycle, then after the Power Meter is triggered, the Power Meter will move back to the wait-for-trigger (Power Meter is never in the IDLE state).
- If INIT:CONT is set to ON, and the INIT:IMM command is sent, error -213, "INIT ignored" occurs.
- ***RST Condition:** INIT:CONT is set to OFF.

Example

To make the Power Meter move continuously to the wait-for-trigger state

```

CONF:POW:AC DEF,0.1DB,DEF Configure the Power Meter
TRIG:SOUR BUS Set trigger source to BUS (Power Meter will be triggered by <GET> or *TRG

INIT:CONT ON Place the Power Meter in wait-for-trigger state; store the measurement result in memory when the trigger is received. The Power Meter reverts back to the wait-for-trigger state after the measurement is completed

*TRG Trigger the Power Meter
FETC? Place the measurement result in the output buffer

enter statement Enter the result into the computer

```

INIT:CONT?

INITiate:CONTInuous? enters 1 or 0 into the output buffer. A response of 1 means the INIT:CONT is set to ON, 0 means that INIT:CONT is set to OFF.

INPut

The **INPut** command subsystem is used to control an HP 11722A Power Sensor. This feature is useful in ATE applications where you may want to measure two different parameters, for example power and frequency, without having to disconnect cables. See Figure 4-4.

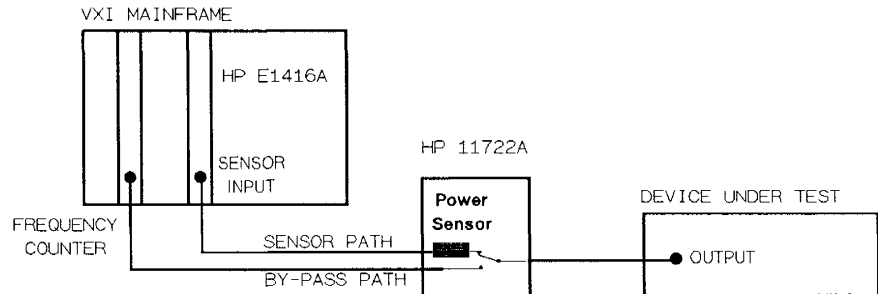

Figure 4-4. Using the HP 11722A Power Sensor

Subsystem Syntax INPut

```
[[:STATe] <mode>
[:STATe]?
```

INP[:STAT]

INPut[:STATe] <mode> is used to control the routing of the signal with an HP 11722A Power Sensor.

Parameters

Parameter Name	Parameter Type	Range of Values	Default Units
<i>mode</i>	boolean	OFF 0 ON 1	none

- Comments**
- **ON|1** routes the signal to the Power Meter (Sensor Path).
 - **OFF|0** routes the signal to the By-Pass path.
 - **CONFigure** and **MEASure** route the signal to the Power Meter.
 - **[[:SENSe]:FUNctioN "POW:AC"** and equivalents route the signal to the Power Meter. (See **[[:SENSe]:FUNctioN** for more information.)
 - ***RST Condition:** **INPut[:STATe] ON|1**

Example To route the signal to the Power Meter

```
:INP ON
```

Route the signal to the power meter

INP[:STAT]?

INPut[:STATe]? enters 1 or 0 into the output buffer. 1 means the signal is routed to the Power Meter (Sensor Path), 0 means the signal is routed to the By-Pass path.

Example To query the status of the signal path

INP ON	<i>Route the signal to the Power Meter</i>
INP?	<i>Query the power meter</i>
enter statement	<i>Enter the value into the computer</i>

MEAS:POW:AC

The **MEASure:POWer:AC?** command configures the Power Meter to perform a power measurement with the given range, resolution and frequency then makes the measurement. MEASure is a compound command which is equivalent to:

```
ABORt
CONFigure:POWer:AC <conf_parm>
READ[:POWer:AC]?
```

Subsystem Syntax

MEASure[:SCALar]:POWer:AC? <conf_parm>

Note

[:SCALar] is an optional parameter and can be omitted.

Parameters

There are three optional parameters for *conf_parm*:

<conf_pow_range>, <conf_res_n>, <conf_frequency>

The parameters must appear in the order specified.

Parameter Name	Parameter Type	Range of Values	Default Units
<i>conf_pow_range</i>	numeric	<pow_range> ¹ AUTO DEF	Defined by UNIT:POW
<i>conf_res_n</i>	numeric	<res_n> ² DEF	Defined by UNIT:POW
<i>conf_frequency</i>	numeric	<frequency> ³ DEF	Hz

1. See [:SENS]:POW:RANG[:UPP] for information about the range of values.
2. See [:SENS]:POW:RES for information about the range of values.
3. See [:SENS]:FREQ for information about the range of values.

Note

The mnemonic DEF means DEFault. This is not equivalent to the DEFault parameter used in other command subsystems. See the Comments in this subsystem for more information.

Comments

- The parameter *conf_pow_range* uses the same command parameter as POW:RANG[:UPP] (see the [:SENSe] subsystem for more information). If AUTO is specified, the Power Meter is switched to autoranging (equivalent to POW:RANG:AUTO ON).
- The parameter *conf_res_n* uses the same command parameter as POW:RES (see the [:SENSe] subsystem for more information).
- The parameter *conf_frequency* uses the same command parameter as FREQ (see the [:SENSe] subsystem for more information). If CAL:CSET:SEL? returns a *table_name*, then CAL:CSET:STAT is set to ON (Data Table system enabled).
- If the *conf_frequency* parameter is specified but no table has been selected (CAL:CSET:SEL <*table_name*>), the frequency is updated but CAL:CSET:STAT is left OFF.
- The parameters must be entered in the correct order. If parameters are omitted, they will default from left to right. The parameter DEFault is used as a placeholder. Specifying DEF leaves the parameter value unchanged. For example, if you want to change the frequency, but want to leave the range and resolution unchanged, you would use the following command:

```
CONF:POW:AC DEF,DEF,15MHZ
```

If you use the following command:

```
CONF:POW:AC 15MHZ
```

error -131, "Invalid Suffix" occurs, since the Power Meter was expecting a range parameter value.

- The CONFigure command also does the following:

ABOR	<i>Places the Power Meter in the idle state</i>
INIT:CONT OFF	<i>Sets the Power Meter to make 1 trigger cycle when INIT is sent</i>
TRIG:SOUR IMM	<i>Sets the Power Meter to make the measurement immediately a trigger is received</i>
TRIG:DEL:AUTO ON	<i>Enables automatic delay before making the measurement</i>
INP:STAT ON	<i>Sets the HP 11722A Power Sensor to Sensor Path</i>
AVER:COUN:AUTO ON	<i>Enables automatic filter length selection</i>

- If suffixes are omitted, the units assumed for frequency are Hz. For range and resolution the units assumed are determined by the setting of UNIT:POW.

Example To make a measurement

```
CAL:CSET "SENSOR_1"
```

```
UNIT:POW DBM
```

```
MEAS:POW:AC? 20DBM,0.1DB,15MHZ
```

```
enter statement
```

*Transfer Data Table Sensor_1
from Editing Space to
Measurement Space*

Set measurement units to dBm

*Configure the Power Meter
to the 20 dBm range, with a
resolution of 0.1 dB, and a
frequency of 15 MHz (used
to calculate the Calibration
Factor for the measurement)*

*Enter the result into the
computer*

MEMory

The MEMory command subsystem is used to create, edit and review Data Tables stored in Editing Space. The subsystem is illustrated in Figure 4-5.

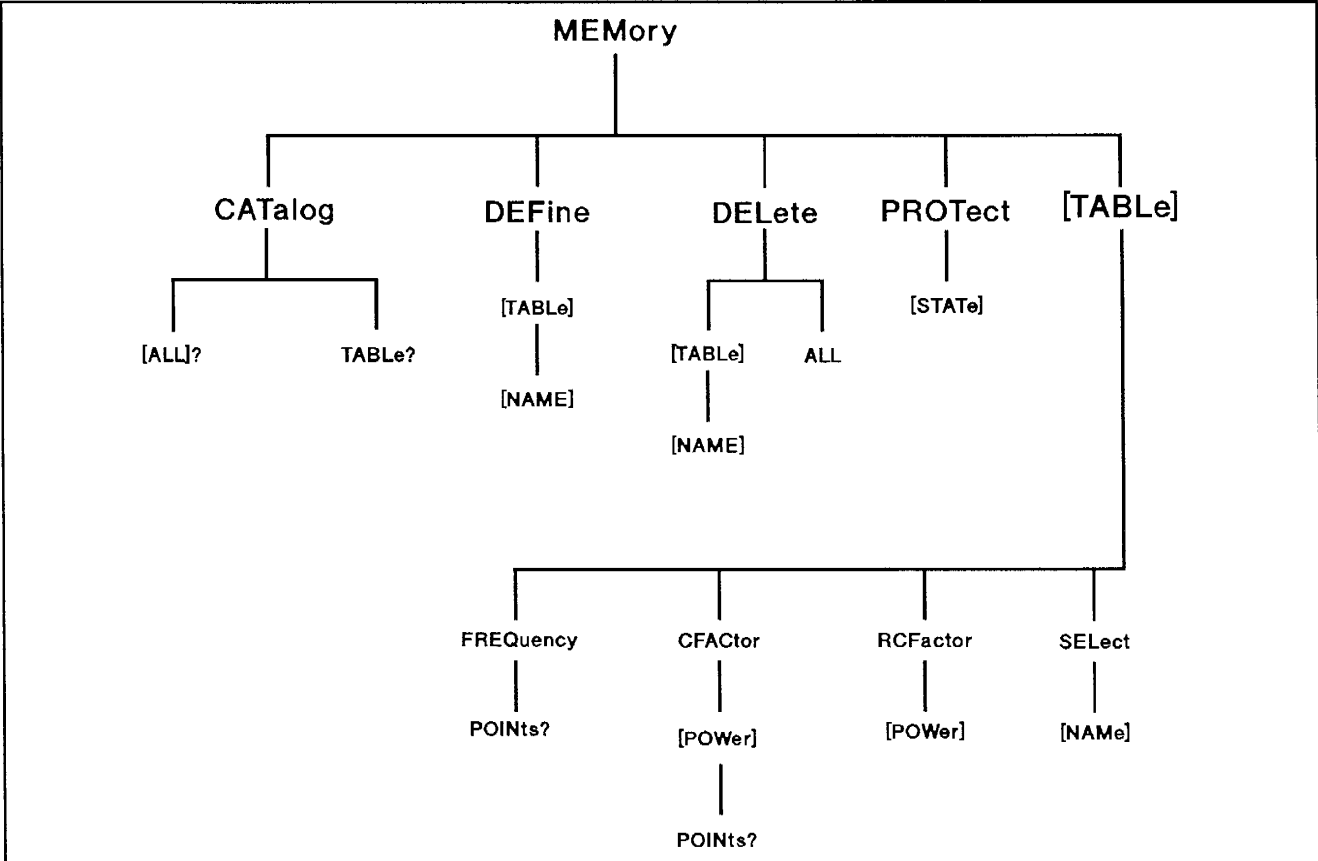

Figure 4-5. MEMory Subsystem

Subsystem Syntax

MEMory

```

:CATalog
  [:ALL]?
  :TABLE?

:DEFine
  [:TABLE]
  [:NAME] <table_name>

:DELete
  [:TABLE]
  [:NAME] <table_name>
  :ALL

:PROTect
  [:STATe] <mode>
  [:STATe]?

[:TABLE]
  :FREQuency <freq_list>
  :FREQuency?
  :POINts?
  :CFACtor
  [:POWer] <cal_fac_list>
  [:POWer]?
  :POINts?
  :RCFactor <ref_cal>
  [:POWer]
  [:POWer]?
  :SElect
  [:NAME] <table_name>
  [:NAME]?

```

MEM:CAT[:ALL]?

MEMory:CATalog[:ALL]? lists the Data Tables stored in Editing Space.

Comments

- The MEM:CAT? command returns a comma seperated list of strings. An example response is:
"Sensor_1", "Sensor_2", "Sensor_3"
- If there are no tables stored in Editing Space a null string is returned ("").
- The Power Meter is shipped with a set of Data Tables. The data in these tables is based on statistical averages for a number of Hewlett-Packard Power Sensors. The Power Sensors are:

TBL100PCT
HP8481A
HP8482A
HP8483A
HP8484A
HP8485A
HP8486A
Q8486A
R8486D
HP8487A

TBL100PCT is a Data Table in which the Reference Calibration Factor and Calibration Factors are 100%. This table can be used during Performance Testing the Power Meter.

- ***RST Condition:** the Data Tables stored in Editing Space are not affected.

Example

To list the Data Tables stored in Editing Space

MEM:CAT?	<i>List the Data Tables stored in Editing Space</i>
enter statement	<i>Enter the Data Table names</i>

Related Commands

MEM:DEF?
MEM:CAT:TABL?

MEM:CAT:TABL?

MEMory:CATalog:TABLE? is an alternative form of the MEM:CAT:[ALL]? command. The commands perform exactly the same function.

MEM:DEF[:TABL][:NAME]

MEMory:DEFine[:TABLE][:NAME] <table_name> is used to create a Data Table in Editing Space.

Comments

- The maximum number of Data Tables you can store in the Power Meter is 10. If you attempt to create a new table when there are already 10 Data Tables, an error will occur.
- Table names can be one of the following types:
 - a. IEEE 488.2 <character program data> as defined in Section 7.1.1
 - b. A string
- If the name is <character program data>, then the following rules apply:
 - a. The table name must consist of no more than 12 characters.
 - b. The first character must be an upper or lower case alpha character (**a-z, A-Z**).
 - c. All other characters must be upper or lower case alpha, or numeric (**0-9**), or an underscore (**_**).
 - d. No other characters are allowed.
- If the name is <character program data>, then all subsequent MEM:CAT? or MEM:CAT:TABLE commands return the alpha characters in upper case. (MEM:DEF "Sensor_1", then MEM:CAT? returns "SENSOR_1").
- If the name is a string, then the following rules apply:
 - a. The table name must consist of no more than 20 characters.
 - b. The first character must be an upper or lower case alpha character (**a-z, A-Z**).
 - c. All other characters must be upper or lower case alpha, or numeric (0-9), or an underscore (**_**).
 - d. No other characters are allowed.
- If the name is a string, then all subsequent MEM:CAT? or MEM:CAT:TABLE commands return the alpha characters with the case preserved. (MEM:DEF "SeNsoR_1", then MEM:CAT? returns "SeNsoR_1").
- For both types, no spaces are allowed in the name.
- The examples in this manual use the string format for table names.

MEMory Subsystem

- The Power Meter is case insensitive to *table_name*. For example the table name SENSOR_5 is identical to Sensor.5. (i.e. you cannot create two tables with the same name.)

Example To create a Data Table

```
MEM:DEF "SENSOR_FOR_TEST_2"      Create a Data Table named  
                                  SENSOR_FOR_TEST_2
```

MEM:DEL[:TABL][:NAME]

MEMory:DELeTe[:TABLe][:NAME] <*table_name*> is used to delete a specified Data Table from Editing Space.

- The MEM:DEL command will only operate when MEM:PROT is set to OFF.
- If you set MEM:PROT OFF, it is recommended that after completing your editing, you re-lock the memory using the MEM:PROT ON command.

Example To delete the Data Table named Sensor_1

```
MEM:PROT OFF      Disable memory protection  
MEM:DEL "Sensor_1" Delete the Data Table named Sensor_1  
MEM:PROT ON      Re-lock the memory (memory  
                  protection enabled)
```

MEM:DEL:ALL

MEMory:DELeTe:ALL is used to delete all the Data Tables from Editing Space.

Note



Use the MEM:DEL ALL command with extreme caution. The command deletes all the tables stored in Editing Space.

Comments

- The MEM:DEL:ALL command will only operate when MEM:PROT is set to OFF.
- If you set MEM:PROT OFF, it is recommended that after completing your editing, you re-lock the memory using the MEM:PROT ON command.

Example To delete all the Data Tables stored in Editing Space

```
MEM:PROT OFF           Disable memory protection
MEM:DEL ALL           Delete all the Data Tables stored in
                       Editing Space
MEM:PROT ON           Re-lock the memory (memory
                       protection enabled)
```

MEM:PROT[:STAT]

MEMory:PROTect:STATe <mode> is used to enable and disable memory protection.

Parameters

Parameter Name	Parameter Type	Range of Values	Default Units
<i>mode</i>	boolean	OFF 0 ON 1	none

- Comments**
- Memory protection is enabled if ON|1 is specified. The MEM:DEL commands will not be carried out.
 - Memory protection is disabled if OFF|0 is specified. The MEM:DEL commands will be carried out.
 - *RST Condition:MEM:PROT is set to ON.

Example To disable memory protection

```
MEM:PROT OFF           Disable memory protection
```

MEM:PROT[:STAT]?

MEMory:PROTectiOn[:STATe]? returns the current setting of memory protection. If the Power Meter returns 1, memory protection is enabled. If the Power Meter returns 0, memory protection is disabled.

Example To find out the current setting of memory protection

```
MEM:PROT OFF           Disable memory protection
MEM:PROT?             Query the Power Meter to return the
                       current setting of memory protection

enter statement       Enter the result into the computer
```

MEM[:TABL]:FREQ

MEMory[:TABLE:]FREQuency <freq_list> is used to enter frequency data into the table currently active in Editing Space (name of table returned by MEM:SEL?).

Parameters

Comments

- If a Data Table has not been specified using the MEM:SEL command, then the data cannot be entered into the table.
- The frequency data overwrites all existing frequency data in the table.
- The data list can be up to 80 entries long. The frequencies must be separated by commas.
- Any legal frequency units suffix multiplier is allowed (see IEEE 488.2, Section 7.7.3). If the frequency units are omitted, the Power Meter assumes the data is Hz.
- The frequency data must be within range (100 KHz to 999.9 GHz).
- The number of Frequency and Calibration Factor data points must be equal. This is not checked until the table is transferred to Measurement Space. The maximum number of data pairs is 80.
- Entries in the data lists must be in a 1-to-1 correspondence. For example the nth data point in the frequency list must be the one associated with the nth data point in the Calibration Factor list. The Power Meter sorts the data pairs by frequency. Therefore the frequency list does not have to be sent in frequency order.
- Ensure that the frequency points you use cover the frequency range of the signals you want to measure. If you measure a signal with a frequency outside the frequency range defined in the table, then the Power Meter uses the highest or lowest frequency point in the table to calculate the Calibration Factor.

Example

To enter frequency data into a Data Table

MEM:SEL "SENSOR_1"

Make Data Table SENSOR_1 active in editing space

MEM:FREQ 5000000,10MHZ,15MHZ

Send 3 frequency points (5, 10 and 15 MHz)

MEM[:TABL]:FREQ?

MEMory[:TABLE]:FREQuency)? returns a list of frequency points for the Data Table currently active in editing space (name of table returned by MEM:SEL?). The frequencies are returned in Hz.

Comments

It is recommended that after issuing this query, you immediately read the result back into the computer. If the frequency list is very long (could be up to 80 data points) and the query is issued several times, the Power Meter's output buffer may overflow and cause an error to be generated.

Example

To list the frequency points for a Data Table

MEM:SEL "SENSOR_1"	<i>Make Data Table SENSOR_1 active in editing space</i>
MEM:FREQ 5000000,10MHZ,15MHZ	<i>Send 3 frequency points (5, 10 and 15 MHz</i>
MEM:FREQ?	<i>Query the Power Meter to return the frequency points for Data Table SENSOR_1</i>
enter statement	<i>Enter the frequency points into the computer</i>

MEM[:TABL]:FREQ:POIN?

MEMory[:TABLE]:FREQuency:POINts)? returns the number of frequency points for the Data Table currently active in editing space (name of table returned by MEM:SEL?).

Example

To list the number of frequency points in a Data Table

MEM:SEL "SENSOR_1"	<i>Make Data Table SENSOR_1 active in editing space</i>
MEM:FREQ 5000000,10MHZ,15MHZ	<i>Send 3 frequency points (5, 10 and 15 MHz</i>
MEM:FREQ:POIN?	<i>Query the Power Meter to return the number of frequency points for Data Table SENSOR_1</i>
enter statement	<i>Enter the number of frequency points into the computer (this will be 3).</i>

MEM[:TABL]:CFAC[:POW]

MEMory[:TABLe]:CFACtor[:POWer] <cal_fac_list> is used to enter Calibration Factor data into the table currently active in Editing Space (name of table returned by MEM:SEL?).

- Comments**
- If a Data Table is not specified using the MEM:SEL command, then the data cannot be entered.
 - The Calibration Factor data overwrites all existing Calibration Factor data for the table selected.
 - The data list can be up to 80 entries long. The Calibration Factors must be separated by commas.
 - The only legal suffix for Calibration Factors is PCT. This can be omitted.
 - The Calibration Factor data must be within range (1PCT to 150PCT).
 - The number of Calibration Factor and Frequency data points must be equal. This is not checked until the table is transferred to Measurement Space. The maximum number of data pairs is 80.
 - Entries in the data lists must be in a 1-to-1 correspondence. For example the nth data point in the frequency list must be the one associated with the nth data point in the Calibration Factor list.

Example To enter Calibration Factor data into a Data Table

```
MEM:SEL "SENSOR_1"      Make Data Table SENSOR_1 active in
                        editing space
MEM:CFAC 98.6,97.8,97.2 Send 3 Calibration Factor points
                        (98.6, 97.8 and 97.2%)
```

MEM[:TABL]:CFAC[:POW]?

MEMory[:TABLe]:CFACtor[:POWer]? returns a list of Calibration Factor points for the Data Table currently active in Editing Space.

- Comments**
- It is recommended that after issuing this query, you immediately read the result back into the computer. If the Calibration Factor list is very long (could be up to 80 data points) and the query is issued several times, the Power Meter's output buffer may overflow and cause an error to be generated.

Example To list the Calibration Factors for a Data Table

MEM:SEL "SENSOR_1"	<i>Make Data Table SENSOR_1 active in editing space</i>
MEM:CFAC 98.2,98.7,99.2	<i>Send 3 Calibration Factor points (98.2, 98.7 and 99.2%)</i>
MEM:CFAC?	<i>Query the Power Meter to return the Calibration Factor points for Data Table SENSOR_1</i>
enter statement	<i>Enter the Calibration Factor points into the computer</i>

MEM[:TABL]:CFAC:POIN?

MEMory[:TABLe]:CFACtor:POINts? returns the number of Calibration Factor points for the Data Table currently active in editing space (name of table returned by MEM:SEL?).

Example To list the number of Calibration Factor points in a Data Table

MEM:SEL "SENSOR_1"	<i>Make Data Table SENSOR_1 active in editing space</i>
MEM:CFAC 98.6,97.8,97.2	<i>Send 3 Calibration Factor points (98.6, 97.8 and 97.2%)</i>
MEM:CFAC:POIN?	<i>Query the Power Meter to return the number of Calibration Factor points for Data Table SENSOR_1</i>
enter statement	<i>Enter the number of Calibration Factor points into the computer (this will be 3).</i>

MEM[:TABL]:RCF[:POW]

MEMory:RCFactor <ref_cal> <pct_suffix>|DEF|MIN|MAX is used to enter a Reference Calibration Factor for the Data Table currently active in editing space (name of table returned by MEM:SEL?).

Comments

- Each Data Table must have a Reference Calibration Factor. The presence of a Reference Calibration Factor is not checked until the Data Table is transferred to Measurement Space.
- If a Data Table is not specified using the MEM:SEL command, then the Reference Calibration Factor cannot be entered.
- The Reference Calibration Factor overwrites any existing Reference Calibration Factor.
- The only legal suffix for Reference Calibration Factor is PCT. This can be omitted.
- The Reference Calibration Factor must be within range (50PCT to 120PCT).
- IF DEF is specified, the Reference Calibration Factor is set to 100%
- IF MIN is specified, the Reference Calibration Factor is set to 50%
- IF MAX is specified, the Reference Calibration Factor is set to 120%

Example

To enter a Reference Calibration Factor into a Data Table

```
MEM:SEL "SENSOR_1"      Make Data Table SENSOR_1 active in  
                        editing space  
MEM:RCF 98.6           Enter the Reference Calibration Factor  
                        (98.6%)
```

MEM[:TABL]:RCF[:POW]?

MEMory[:TABLE]:RCFactor[:POWER]? returns the value of the Reference Calibration Factor for the Data Table currently active in Editing Space (name of table returned by MEM:SEL?).

Example

To query the value of the Reference Calibration Factor in a Data Table

```
MEM:SEL "SENSOR_1"      Make Data Table SENSOR_1 active in  
                        editing space  
MEM:RCF 98.6           Enter the Reference Calibration Factor  
                        (98.6%)  
MEM:RCF?               Query the Power Meter  
enter statement        Enter the value of the Reference  
                        Calibration Factor (98.6%)
```

MEM[:TABL]:SEL[:NAME]

MEMory[:TABLe]:SElect[:NAME] <table_name>|DEF|OPTIONAL
is used to activate a Data Table in Editing Space. A Data Table must be activated in Editing Space before data is entered into it.

- Comments**
- If *table_name* does not exist, an error occurs.
 - If *table_name* is not specified, or DEF is specified, then the last Data Table created is activated (for example, *table_name* returned by MEM:DEF?).
 - ***RST Condition:** the Data Table active in Editing Space is not affected.

Example To activate a Data Table in Editing Space

MEM:SEL "SENSOR_1" *Make the Data Table named
SENSOR_1 active in Editing Space*

MEM[:TABL]:SEL[:NAME]?

MEMory[:TABLe]:SElect[:NAME]? returns the *table_name* of the Data Table currently active in Editing Space.

Example To query the name of the Data Table active in Editing Space

MEM:SEL "SENSOR_1" *Make the Data Table named
SENSOR_1 active in Editing Space*

MEM:SEL? *Query the Power Meter to return the
name of the Data Table active in
Editing Space*

enter statement *Enter the table name into the
computer, result is "SENSOR_1"*

OUTPut

The **OUTPut** command subsystem is used to switch on and off the **POWER REF** output, and to query its status.

Subsystem Syntax

OUTPut
:ROSCillator
[:STATe] <mode>
[:STATe]?

OUTP:ROSC[:STAT]

OUTPut:ROSCillator[:STATe] <mode> is used to switch on and off the **POWER REF** output.

Parameters

Parameter Name	Parameter Type	Range of Values	Default Units
<i>mode</i>	boolean	OFF 0 ON 1	none

Comments

- OFF|0 switches off the Power Ref output.
- ON|1 switches on the Power Ref output.
- ***RST Condition.** Power Ref output is switched OFF.

Example

To switch on the **POWER REF** output

OUTP:ROSC ON *Switch on the power ref output*

OUTP:ROSC[:STAT]?

OUTPut:ROSCillator[:STATe]? enters 1 or 0 into the output buffer. 1 means the Power Ref output is on, 0 means the Power Ref output is off.

Example

To query the status of the **POWER REF** output

OUTP:ROSC ON *Switch on the power ref output*
OUTP:ROSC? *Query the power meter*
enter statement *Enter the value into the computer*

READ[:POW:AC]?

The **READ[POW:AC]?** command is most commonly used with **CONFigure** to cause a new power measurement to be taken and the result returned to the output buffer.

Subsystem Syntax

READ[:POW:AC]?

Comments

- TRIG:SOUR must be set to IMM, otherwise error -214, “Trigger deadlock” occurs.
- If INIT:CONT is ON when READ? is sent, error -213, “INIT ignored” occurs.
- Each reading sent to the output buffer contains 12 bytes (characters) in Real ASCII format:

$\pm 1.2345 \pm E67LF$

Each measurement is terminated with a Line Feed (*LF*). The HP-IB End-or-Identify (EOI) signal is sent with the last byte transferred.

Example

To transfer a measurement result directly into the output buffer

CONF:POW:AC DEF,0.1dB,DEF *Configure the Power Meter*

READ? *Make a measurement and put the result in the output buffer*

enter statement *Enter the result into the computer*

Related Commands

CONFigure
 FETCh?

[SENSe]

The **SENSe** command subsystem directly affects device-specific settings used to make measurements. The **SENSe** node is optional since this is the primary function of the Power Meter. The high level command **CONFigure** uses the **SENSe** commands to prepare the Power Meter for making measurements. At a lower level **SENSe** enables you to change the following parameters without completely re-configuring the Power Meter:

- RANGe
- RESolution
- FREQuency
- LOSS
- GAIN
- DCYClE (Duty Cycle)
- REFerence (Relative Power Measurement)

The subsystem is illustrated in Figure 4-6.

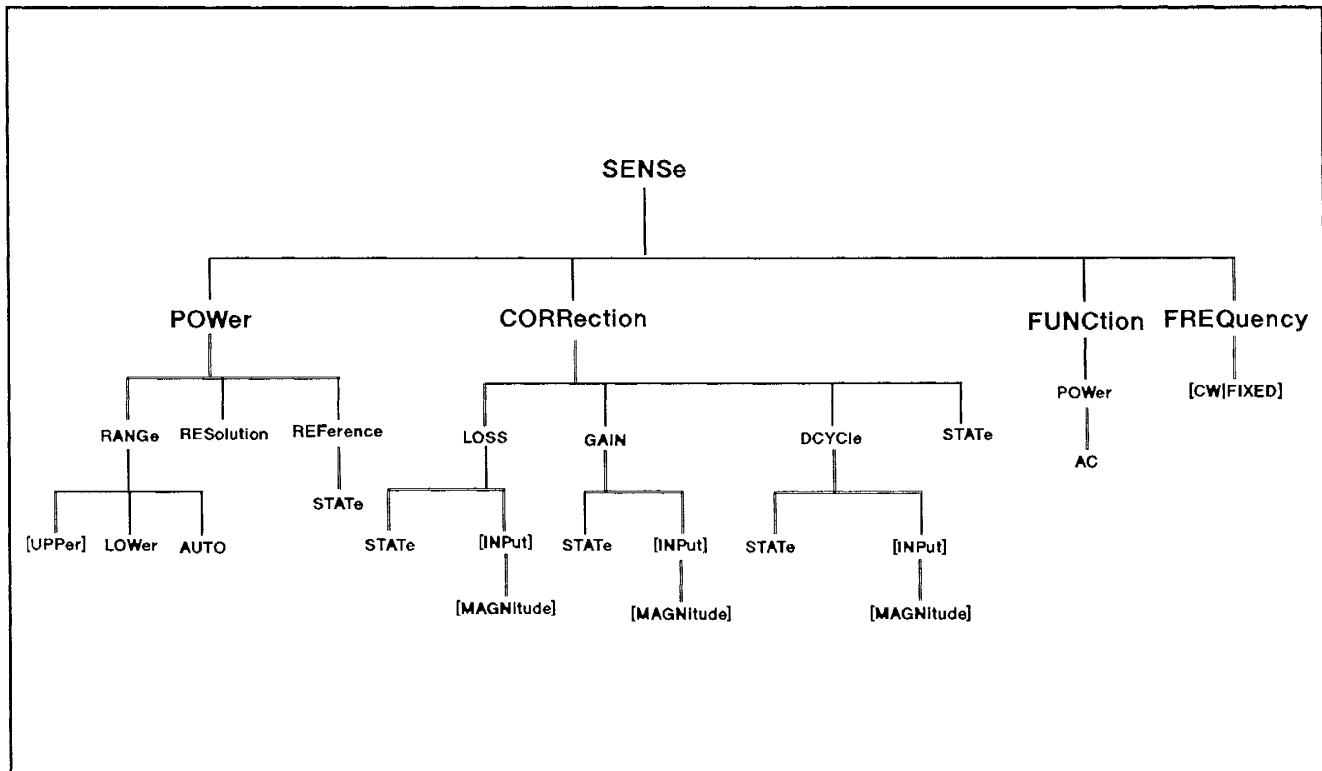

Figure 4-6. **SENSe** Subsystem

Note



The examples provided in the **SENSe** subsystem are for an HP 8482A Power Sensor.

Subsystem Syntax [:SENSe]

```

:POWer
:RANGe
  [:UPPer] <pow_range>
  [:UPPer]?
  :LOWer <pow_range>
  :LOWer?
  :AUTO <mode>
  :AUTO?
:RESolution <res_n>
:RESolution?
:REFerence <ref_lev>
:REFerence?
  :STATe <mode>
  :STATe?
:CORRection
  [:STATe]
  [:STATe]?
:LOSS
  :STATe <mode>
  :STATe?
  [:INPut]
  [:MAGNitude] <loss_lev>
  [:MAGNitude]?
:GAIN
  :STATe <mode>
  :STATe?
  [:INPut]
  [:MAGNitude] <gain_lev>
  [:MAGNitude]?
:DCYClE
  :STATe <mode>
  :STATe?
  [:INPut]
  [:MAGNitude] <duty_cycle>
  [:MAGNitude]?
:FUNcTION <function>
  :POWer
  :AC
:FUNcTION?
:FREQUency <frequency>
  [:CW]:FIXed
  [:CW]:FIXed?

```

Note

The root command [:SENSe] is an optional parameter and can be omitted

POW:RANG[:UPP]

POW:RANG[:UPP] *<pow_range>* [*pow_suffix*] sets the Power Meter range to one of five decade ranges. The ranges are dependent by the Power Sensor being used.

Parameters

Parameter Name	Parameter Type	Range of Values	Default Units
<i>pow_range</i>	numeric	sensor dependent DEF MIN MAX	Defined by UNIT:POW

Comments

- Specifying this command causes the Power Meter to select a range assuming that *pow_range* will be the highest power you want to measure. In any range except the lowest, if *pow_range* is less than 20% of the range (converted to linear units), then the Power Meter will select the next lowest range. Specifying this command sets autoranging OFF (POW:RANG:AUTO OFF).
- If a numeric value is specified, any legal *pow_suffix* is allowed, where *pow_suffix* is:

IEEE 488.2 *<suffix_multiplier>*W
 DB*<suffix_multiplier>*W
 DBM

If *pow_suffix* is omitted, then the units assumed are those set by UNIT:POW.

- If DEF is specified, the center range of the 5 decades is selected.
- If MIN is specified, the lowest range of the 5 decades is selected.
- If MAX is specified, the highest range of the 5 decades is selected.
- If the input signal exceeds 120% of the range, error -231 “Data questionable;UP RANGE” occurs.
- ***RST Condition:** autoranging is switched ON (POW:RANG:AUTO ON), therefore the center range is selected.

Example To select a Power Meter range

```
UNIT:POW W
POW:RANG 1.1mW
```

*Set measurement units to watts
 Maximum power level to be measured
 is 1.1 mW. Power Meter selects the
 center range*

POW:RANG[:UPP]?

POW:RANGe[:UPPer]? [DEF|MIN|MAX] returns one of the following numbers to the output buffer:

- The upper value of the center range if DEF is specified.
- The upper value of the lowest range if MIN is specified.
- The upper value of the highest range if MAX is specified.
- The upper end of the range the Power Meter is currently in if DEF|MIN|MAX is not specified.

Comments

- If UNIT:POW is W, the result is in Watts.
- IF UNIT:POW is DBM, the result is in dBm.

Example

To query the upper end of the current range

```
UNIT:POW W           Set measurement units to watts
POW:RANG 1.1mW      Maximum power level to be measured
                    is 1.1 mW. Power Meter selects the
                    center range

POW:RANG?           Query the Power Meter
enter statement     Enter the result into the computer,
                    result is +1.0000E-03
```

POW:RANG:LOW

POW:RANGe:LOWer <pow_range> [pow_suffix] sets the Power Meter range to one of five decade ranges. The ranges are determined by the Power Sensor being used.

Parameters

Parameter Name	Parameter Type	Range of Values	Default Units
<i>pow_range</i>	numeric	sensor dependent DEF MIN MAX	Defined by UNIT:POW

Comments

- Specifying this command causes the Power Meter to select a range assuming that *pow_range* will be the lowest power you want to measure. In any range except the highest, if *pow_range* is more than 90% of the range (converted to linear units), then the Power Meter will select the next highest range. Specifying this command sets autoranging OFF (POW:RANG:AUTO OFF).
- If a numeric value is specified, any legal *pow_suffix* is allowed, where *pow_suffix* is:

```
IEEE 488.2 <suffix_multiplier>W
DB<suffix_multiplier>W
DBM
```

[SENSe] Subsystem

If *pow_suffix* is omitted, then the units assumed are those set by UNIT:POWer.

- If DEF is specified, the center range of the 5 decades is selected.
- If MIN is specified, the lowest range of the 5 decades is selected.
- If MAX is specified, the highest range of the 5 decades is selected.
- ***RST Condition:** autoranging is switched ON (POW:RANG:AUTO ON), therefore the center range is selected.

Example To select a Power Meter range

```
UNIT:POW W           Set measurement units to watts  
POW:RANG:LOW 0.8mW  Minimum power level to be measured  
                     is 0.8mW. Power Meter selects the  
                     center range
```

POW:RANG:LOW?

POWer:RANGe:LOWer? [DEF|MIN|MAX] returns one of the following numbers to the output buffer:

- The lower value of the center range if DEF is specified.
- The lower value of the lowest range if MIN is specified.
- The lower value of the highest range if MAX is specified.
- The lower end of the range the Power Meter is currently in if DEF|MIN|MAX is not specified.

- Comments**
- If UNIT:POW is W, the result is in Watts.
 - IF UNIT:POW is DBM, the result is in dBm.

Example To query the lower end of the current range

```
UNIT:POW W           Set measurement units to watts  
POW:RANG:LOW 0.8mW  Minimum power level to be measured  
                     is 0.8 mW. Power Meter selects the  
                     center range  
  
POW:RANG:LOW?       Query the Power Meter  
enter statement     Enter the result into the computer,  
                     result is +1.0000E-03
```

POW:RANG:AUTO

POWer:RANGe:AUTO <mode> is used to turn autoranging ON or OFF. When autoranging is ON, the Power Meter selects the best range for measuring the power after receiving a trigger.

Parameters

Parameter Name	Parameter Type	Range of Values	Default Units
<i>mode</i>	boolean	OFF 0 ON 1	none

Comments

- 1|ON enables autoranging.
- 0|OFF disables autoranging. Range is set by POW:RANGE[:UPP] or :LOW.
- POW:RANG[:UPP] and :LOW disable autoranging.
- If INIT:CONT is set to ON and TRIG:SOUR is set to IMM, the range will track input power if POW:RANG:AUTO ON.
- If the Power Meter is not making measurements, then the autoranging will only occur when the Power Meter is triggered.
- ***RST Condition:** autoranging is enabled (POW:RANG:AUTO ON).

POW:RANG:AUTO?

POWer:RANGe:AUTO? enters 1 or 0 into the output buffer. A response of 1 means that autoranging is enabled, 0 means that autoranging is disabled.

POW:RES

POWer:RESolution <res_n> <res_suffix> is used to set the Power Meter resolution.

Parameters

Parameter Name	Parameter Type	Range of Values	Default Units
<i>res_n</i>	numeric	<i>see next table</i> DEF MIN MAX	Defined by UNIT:POW

UNIT:POW	MIN	DEF	MAX	RESOLUTION UNITS (<i>res_suffix</i>)
DBM	0.001	0.01	0.1	dB
W	0.01% of full scale	0.1% of full scale	1% of full scale	< <i>suffix_multiplier</i> >W

- Comments**
- Resolution can be specified in dB or W. If *pow_suffix* is omitted, then the units assumed are those set by UNIT:POWER.
 - If UNIT:POWER is DBM, then independent of range, resolution can always be set to 0.1, 0.01 or 0.001 dB.
 - If UNIT:POWER is W then resolution is determined by the range the Power Meter is currently set to. For example, to set a resolution that is 1% of full scale, when POW:RANG:UPP 1 MW the following command would be used:

```
POW:RES 1E-05 W
```

Similarly to set 0.1% and .01% resolutions the following commands would be used:

```
POW:RES 1E-06 W
POW:RES 1E-07 W
```
 - The Power Meter converts the number to one of the allowable resolutions. The breakpoint between resolutions is the midpoint between scales. For example, setting POW:RANG:UPP 1 MW, then POW:RES 0.0049 MW, sets the resolution to to 0.001 mW (0.1%). If POW:RES is set to 0.0051 mW, the resolution is set to 0.01 mW (1%).
 - ***RST Condition:** the resolution is set to 0.1% of full scale, 0.01 dB.

Example **To set the Power Meter for best resolution**

```
UNIT:POW DBM                      Set measurement units to dBm
POW:RES MIN                        Set best resolution
```

POW:RES?

POW:RESolution? [DEF|MIN|MAX] returns one of the following numbers to the output buffer:

- 0.10% of full scale, 0.01 dB if DEF is specified.
- 0.01% of full scale, 0.001 dB if MIN is specified.
- 1.00% of full scale, 0.1 dB if MAX is specified.
- The current resolution of the Power Meter if DEF|MIN|MAX is not specified.

Comments

- The query command returns the current resolution of the Power Meter. The response is 0.1, 0.01 or 0.001 dB when UNIT:POW is DBM, and is in Watts when UNIT:POW is W.

Example

To query the current resolution

```
UNIT:POW DBM           Set measurement units to dBm
POW:RES MIN           Set best resolution
POW:RES?             Query the Power Meter
enter statement      Enter the result into the computer,
                    result is +1.0000E-03
```

POW:REF

POW:REFerence <ref_lev> <pow_suffix> is used to set the reference level for relative power measurements.

Parameters

Parameter Name	Parameter Type	Range of Values	Default Units
ref_lev	numeric	-199.99 dBm to +99.99 dBm DEF MIN MAX	Defined by UNIT:POW

Comments

- If <pow_suffix> is omitted, then the units assumed are those set by UNIT:POW. If UNIT:POW is DBM, ref_lev can be set in Watts. Similarly, if UNIT:POW is W, ref_lev can be set in dBm.
- If DEF is specified, ref_lev is set to 0 dBm (1.00 mW).
- If MIN is specified, ref_lev is set to -199.99 dBm.
- If MAX is specified, ref_lev is set to +99.99 dBm.
- To enable the relative power measurement feature, use the POW:REF:STAT ON command.
- ***RST Condition:** ref_lev is set to 0 dBm (1 mW).

Example To set a reference level

```
UNIT:POW DBM           Set measurement units to dBm
POW:REF -10           Set a reference level of -10 dBm
```

POW:REF?

POWER:REFERENCE? [DEF|MIN|MAX] returns one of the following numbers to the output buffer:

- 0 dBm if DEF is specified.
- -199.99 dBm if MIN is specified.
- +99.99 dBm if MAX is specified.
- The current *ref_lev* if DEF|MIN|MAX is omitted. This is the reference level used to calculate measurement results when REF:STAT is ON.

Example To query the reference level

```
UNIT:POW DBM           Set measurement units to dBm
POW:REF -10           Set a reference level of -10 dBm
POW:REF?             Query the Power Meter
enter statement       Enter the result into the computer,
                    result is -1.0000E+01
```

POW:REF:STAT

POWER:REFERENCE:STATe <mode> is used to enable and disable the relative power measurement feature.

Parameters

Parameter Name	Parameter Type	Range of Values	Default Units
<i>mode</i>	boolean	OFF 0 ON 1	none

Comments

- 1|ON enables the relative power measurement feature. The Power Meter returns measurement results relative to the value set using POW:REF *ref_lev*.
- 0|OFF disables the relative power measurement feature.
- When UNIT:POW is DBM, measurement results are dB (relative).
- When UNIT:POW is W, measurement results are percentage.
- ***RST Condition:** relative power measurement disabled (POW:REF:STAT OFF).

Example To enable the relative power measurement feature

```

UNIT:POW DBM           Set measurement units to dBm
POW:REF -10           Set a reference level of -10 dBm
POW:REF:STAT ON      Enable relative power measurement
                     feature

```

POW:REF:STAT?

POW:REF:STAT? enters 1 or 0 into the output buffer. A response of 1 means that the relative power measurement feature is enabled, 0 means that the feature is disabled.

CORR[:STAT]

CORRection[:STATe] *<mode>* is the global correction state switch.

Parameters

Parameter Name	Parameter Type	Range of Values	Default Units
<i>mode</i>	boolean	OFF 0 ON 1	none

Comments

- This command does not enable the individual corrections (LOSS, GAIN, DCYClE). Use the associated STATE commands to enable/disable a correction.

****RST Condition:** CORR:STAT is OFF (corrections disabled).

Example To enable the corrections

```

UNIT:POW DBM           Set measurement units to dBm
CORR:LOSS -30DB       Set a loss correction of -30 dB
CORR:STAT ON          Enable the corrections
CORR:LOSS:STAT ON     Enable loss correction

```

CORR:STAT?

CORRection:STATe? enters 1 or 0 into the output buffer. A response of 1 means that the corrections are enabled, 0 means that the corrections are disabled.

CORR:LOSS:STAT

CORRection:LOSS:STATe *<mode>* is used to enable or disable a LOSS correction. Since LOSS and GAIN form a coupled system, the command is identical to **CORR:GAIN:STAT** *<mode>*.

Parameters

Parameter Name	Parameter Type	Range of Values	Default Units
<i>mode</i>	boolean	OFF 0 ON 1	none

Comments

- 1|ON enables loss/gain correction.
- 0|OFF disables loss/gain correction.
- Correction will not occur unless CORR:STAT is ON.
- Use CORR:GAIN *gain_lev* or CORR:LOSS *loss_lev* to enter the loss/gain data.
- ***RST Condition:** CORR:LOSS:STAT is OFF (loss/gain correction disabled)

Example

To enable loss correction

```
UNIT:POW DBM           Set measurement units to dBm
CORR:LOSS -30DB        Set a loss correction of -30 dB
CORR:STAT ON           Enable corrections
CORR:LOSS:STAT ON     Enable loss correction
```

CORR:LOSS:STAT?

CORRection:LOSS:STATe? enters 1 or 0 into the output buffer. A response of 1 means that loss correction is enabled, 0 means that loss correction is disabled.

CORR:LOSS[:INP][:MAG]

CORRection:LOSS[:INPut][:MAGNitude] <loss_lev> is used to enter a value for loss correction.

Parameters

Parameter Name	Parameter Type	Range of Values	Default Units
<i>loss_lev</i>	numeric	–99.99 dB to +99.99 dB DEF MIN MAX	dB

Comments

- DEF sets *loss_lev* to 0.00 dB.
- MIN sets *loss_lev* to –99.99 dB.
- MAX sets *loss_lev* +99.99 dB.
- Since CORR:LOSS and CORR:GAIN are coupled systems, a loss set by CORR:LOSS is mirrored by the CORR:GAIN? command. For example, if CORR:LOSS is set to –10 dB, CORR:GAIN? returns +10 dB.
- ***RST Condition:** CORR:LOSS (:GAIN) is set to 0.0 dB.

Example

To enter a loss correction

```
UNIT:POW DBM           Set measurement units to dBm
CORR:LOSS -30DB        Set a loss correction of –30 dB
CORR:LOSS:STAT ON     Enable loss correction
CORR:STAT ON           Enable corrections
```

CORR:LOSS[:INP][:MAGN]?

CORRection:LOSS[:INPut][:MAGNitude]? [DEF|MIN|MAX] returns one of the following numbers to the output buffer:

- 0.00 dB if DEF is specified.
- –99.99 dB if MIN is specified.
- +99.99 dB if MAX is specified.
- The current *loss_lev* if DEF|MIN|MAX is omitted. If CORR:GAIN has been used to set *gain_lev*, the result of CORR:LOSS? will be the negative of the value (if expressed in dB).

CORR:GAIN:STAT

CORRection:GAIN:STATe <mode> is used to enable or disable a GAIN correction. Since GAIN and LOSS form a coupled system, the command is identical to **CORR:LOSS:STAT** <mode>.

Parameters

Parameter Name	Parameter Type	Range of Values	Default Units
mode	boolean	OFF 0 ON 1	none

- Comments**
- 1|ON enables loss/gain correction.
 - 0|OFF disables loss/gain correction.
 - Correction will not occur unless CORR:STAT is ON.
 - Use CORR:GAIN *gain_lev* or CORR:LOSS *loss_lev* to enter the loss/gain data.
 - ***RST Condition:** CORR:GAIN:STAT is OFF (loss/gain correction disabled)

Example To enable gain correction

```
UNIT:POW DBM           Set measurement units to dBm
CORR:GAIN 30DB         Set a gain correction of 30 dB
CORR:GAIN:STAT ON     Enable gain correction
CORR:STAT ON          Enable corrections
```

CORR:GAIN:STAT?

CORRection:GAIN:STATe? enters 1 or 0 into the output buffer. A response of 1 means that gain correction is enabled, 0 means that gain correction is disabled.

CORR:GAIN[:INP][:MAG]

CORRection:GAIN[:INPut][:MAGnitude] <gain_lev> is used to enter a value for gain correction.

Parameters

Parameter Name	Parameter Type	Range of Values	Default Units
<i>gain_lev</i>	numeric	−99.99 dB to +99.99 dB DEF MIN MAX	dB

- Comments**
- DEF sets *gain_lev* to 0.00 dB.
 - MIN sets *gain_lev* to +99.99 dB.
 - MAX sets *gain_lev* −99.99 dB.
 - Since CORR:GAIN and CORR:LOSS are coupled systems, a gain set by CORR:GAIN is mirrored by the CORR:LOSS? command. For example, if CORR:GAIN is set to +10 dB, CORR:GAIN? returns −10 dB.
 - ***RST Condition:** CORR:GAIN (:LOSS) is set to 0.0 dB.

Example To enter a gain correction

```
UNIT:POW DBM           Set measurement units to dBm
CORR:GAIN 30DB         Set a gain correction of +30 dB
CORR:GAIN:STAT ON     Enable gain correction
CORR:STAT ON          Enable corrections
```

CORR:GAIN[:INP][:MAGN]?

CORRection:GAIN[:INPut][:MAGNitude]? [DEF|MIN|MAX]
returns one of the following numbers to the output buffer:

- 0.00 dB if DEF is specified.
- −99.99 dB if MIN is specified.
- +99.99 dB if MAX is specified.
- The current *gain_lev* if DEF|MIN|MAX is omitted. If CORR:LOSS has been used to set *loss_lev*, the result of CORR:GAIN? will be the negative of the value (if expressed in dB).

CORR:DCYC:STAT

CORRection:DCYCLe:STATe <mode> is used to enable or disable the pulse power measurement feature.

Parameters

Parameter Name	Parameter Type	Range of Values	Default Units
mode	boolean	OFF 0 ON 1	none

Comments

- 1|ON enables the pulse power measurement feature.
- 0|OFF disables the pulse power measurement feature.
- Correction will not occur unless CORR:STAT is ON.
- Use CORR:DCYC *duty_cycle* to enter the duty cycle of the signal you want to measure.
- ***RST Condition:** CORR:DCYC:STATe is set to OFF.

Example

To enable the pulse power measurement feature

```
CORR:DCYC 50           Set the duty cycle to 50%
CORR:DCYC:STAT ON     Set the Power Meter to make pulse
                       power measurements
CORR:STAT ON          Enable corrections
```

CORR:DCYC:STAT?

CORRection:DCYCLe:STATe? enters 1 or 0 into the output buffer. A response of 1 means that the pulse power measurement feature is enabled, 0 means that the feature is disabled.

CORR:DCYC[:INP][:MAGN]

CORRection:DCYCLe[:INPut][:MAGNitude] <duty_cycle> [*pct_suffix*] is used to set the duty cycle for the pulse power measurement feature. The result returned for a pulse power measurement is a mathematical representation of the pulse power rather than an actual measurement. The Power Meter measures the average power the pulsed input signal and then divides the result by the duty cycle value to obtain a pulse power reading.

Parameters

Parameter Name	Parameter Type	Range of Values	Default Units
<i>duty_cycle</i>	numeric	1 to 100PCT DEF MIN MAX	PCT

Comments

- DEF sets *duty_cycle* to 100%.
- MIN sets *duty_cycle* to 1%.
- MAX sets *duty_cycle* to 100%.
- PCT is the only legal unit for *duty_cycle* and can be omitted.
- Pulse power averages out any aberrations in the pulse such as overshoot or ringing. For this reason it is called pulse power and not peak power or peak pulse power.
- In order to to ensure accurate pulse power readings, the input signal must be pulsed with a rectangular pulse. Other pulse shapes (such as triangle, chirp or Gaussian) will cause erroneous results.
- ***RST Condition:** CORR:DCYC is set to 100% (+1.0000E+02).

Example

To measure a pulse signal with a duty cycle of 50%

```

CORR:DCYC 50           Set the duty cycle to 50%
CORR:DCYC STAT ON     Enable the pulse power measurement
                        feature

CORR:STAT ON          Enable corrections
TRIG:SOUR IMM         Set trigger source to IMMEDIATE
INIT                  Make the Power Measurement
FETC?                 Transfer the result from memory to
                        the output buffer

enter statement       Enter the result into the computer

```

CORR:DCYC[:INP][:MAGN]?

CORRection:DCYCl[:INPut][:MAGNitude]? [DEF|MIN|MAX]
returns one of the following numbers to the output buffer:

- 100 % if DEF is specified.
- 1 % if MIN is specified.
- 100 % if MAX is specified.
- The current *duty_cycle* if DEF|MIN|MAX is omitted.

FUNC

FUNCtion <*function*> is used to set the signal routing to Sensor Path when the Power Meter is being used with an HP 11722A Power Sensor (equivalent to the INP:STAT ON command). The only legal value for *function* is “POWER:AC”, or any legal form of “POWER:AC” (i.e. “POW:AC”, “POW:ac”). The *function* must be sent as a quoted string (“POW:AC”).

FUNC:POW:AC

FUNCtion:POWER:AC is alternative form for FUNC *function*. The query command FUNCtion? always returns “POW:AC”.

FREQ[:CW|:FIX]

FREQuency[:CW|:FIXed] <*frequency*> [*hz_suffix*] is used to enter a frequency. The Power Meter uses linear interpolation to calculate the Calibration Factor for the frequency entered if CAL:CSET:STAT is ON.

Parameters

Parameter Name	Parameter Type	Range of Values	Default Units
<i>frequency</i>	numeric	100 kHz to 999.9 GHz DEF MIN MAX	Hz

Comments

- DEF sets *frequency* to 50.0E06 Hz (50 MHz)
- MIN sets *frequency* to 100.0E03 Hz (100 kHz)
- MAX sets *frequency* to 999.90E09 Hz (999.9 GHz)
- *hz_suffix* can be:
 - MHZ
 - IEEE 488.2 <*suffix_multiplier*> Hz
- If *hz_suffix* is omitted, the units assumed are Hz.
- FREQuency does not set CAL:CSET:STAT ON.
- ***RST Condition** *frequency* is set to 50.0E06 (50 MHz).

Example To enter a frequency

CAL:CSET "Sensor_1"

CAL:CSET:STAT ON

FREQ 120 MHZ

*Transfer Data Table named Sensor_1 into measurement space**Enable the Data Table System**Set the measurement frequency to 120 MHz. The Power Meter uses the frequency to calculate the Calibration Factor*

FREQ?**FREQ**uency? [DEF|MIN|MAX] returns one of the following numbers to the output buffer:

- +5.0000E+07 if DEF is specified.
- +1.0000E+05 if MIN is specified.
- +9.9990E+11 if MAX is specified.
- The current *frequency* if DEF|MIN|MAX is omitted. This is the frequency used to calculate the Calibration Factor if CAL:CSET:STAT is ON.

STATUS

The STATUS command subsystem enables you to examine the status of the Power Meter by monitoring the Operation Status Register and Questionable Status Register. An overview of these registers is contained in *Section 3 - Status Reporting*.

The following table summarizes the effects of various commands/events on the status data structures in the Power Meter.

Command or Event	TMSL Transition Filters	TMSL Enable Registers	TMSL Event Registers	IEEE 488.2 Enable Registers	IEEE 488.2 Event Registers
*RST	none	none	none	none	none
*CLS	none	none	clear	none	clear
Power-on	none	none	none	clear	clear
STATUS:PRESet	preset	preset	none	none	none

Subsystem Syntax

```

STATUS
:OPERation
:EVENT?
:CONDition?
:ENABle
:ENABle?
:NTRansition
:NTRansition?
:PTRansition
:PTRansition
:QUEStionable
:EVENT?
:CONDition?
:ENABle
:ENABle?
:NTRansition
:NTRansition?
:PTRansition
:PTRansition
:PRESet
    
```

STAT:OPER[:EVEN]?

STATus:OPERation[:EVENT]? returns a 16 bit decimal-weighted number representing the bits set in the Operation Status Register Event Register. This command clears all bits in the register to 0.

STAT:OPER:COND?

STATus:OPERation:CONDition? returns a 16 bit decimal-weighted number representing the bits set in the Operation Status Register Condition Register. Reading the Condition Register does not destroy its contents. The following table indicates the bits used by the Power Meter.

Bit No.	Decimal Weight	Meaning
0	1	CALibrating
1	-	Not used
2	4	RANGing
3,4	-	Not used
5	32	Waiting for TRIGger Summary
6-10	-	Not used
11	2048	Lower Limit Fail
12	4096	Upper Limit Fail
13	-	TMSL Reserved
14,15	-	Not used (Bit 15 always 0)

The following table contains information about the conditions in the Power Meter which cause the bits to be set (COND_SET) or cleared (COND_CLEAR).

STATus Subsystem

Bit No.	Meaning	EVENTs Causing/ Bit Changes
0	CALibrating	<p>COND.SET: At beginning of zeroing (:CAL:ZERO:AUTO ONCE) and At the beginning of calibration (:CAL:AUTO ONCE). Also for the compound command/query :CAL[:ALL]?, this bit is set at the beginning of the calibration.</p> <p>COND.CLEAR: At the end of zeroing, calibration or when the calibration sequence terminates.</p>
2	RANGing	<p>COND.SET: When the Power Meter is set to auto-range (:POW:RANG:AUTO ON) and a measurement is taken that falls into a different range relative to the one that the Power Meter is currently set in.</p> <p>COND.CLEAR: While making a measurement, if the Power Meter had to change range, this occurs once it has found the range for the measurement.</p>
5	Waiting for TRIGger Summary	<p>COND.SET: When the Power Meter is INITiated (INIT[:IMM] or INIT:CONT ON) and the trigger is set to BUS or HOLD (TRIG:SOUR BUS HOLD).</p> <p>COND.CLEAR: If TRIG:SOUR BUS and *TRG or <GET> is received or TRIG:SOUR HOLD and TRIG:IMM is received.</p>
11	Lower Limit Fail	<p>COND.SET: If a power measurement is made and the lower limit test fails. The lower limit test is active when CALC:LIM:STAT ON and CALC:LIM:LOW:STAT ON. The lower limit is set by :CALC:LIM:LOW <low_lim> and the limit test fails when the power reading falls below <low_lim>.</p> <p>COND.CLEAR: If a power measurement is made and the lower limit test is not enabled or the test is enabled and passes.</p>
12	Upper Limit Fail	<p>COND.SET: If a power measurement is made and the upper limit test fails. The upper limit test is active when CALC:LIM:STAT ON and CALC:LIM:UPP:STAT ON. The upper limit is set by :CALC:LIM:UPP <upp_lim> and the limit test fails when the power reading falls above <upp_lim>.</p> <p>COND.CLEAR: If a power measurement is made and the upper limit test is not enabled or the test is enabled and passes.</p>

STAT:OPER:ENAB

STATus:OPERation:ENABle *<nrf>* sets the Operation Status Register Status Enable Register. The value *<nrf>* is a 16-bit decimal-weighted integer. Setting a bit causes a 1 to be written to the summary bit 7 of the Status Register when the transition filters are initialized and a COND_SET and/or COND_CLEAR occurs in the corresponding bit. At STATus:PRESet the register is set to all 0's.

STAT:OPER:ENAB?

STATus:OPERation:ENABle? returns a 16 bit decimal-weighted number and is the contents of the Operation Status Register Enable Register. After STATus:PRESet the register is set to all 0's.

STAT:OPER:NTR

STATus:OPERation:NTRansition *<nrf>* Command sets the Operation Status Register Negative Transition Register, where *<nrf>* is a 16-bit decimal-weighted number. Setting a bit causes a 1 to be written to the corresponding bit in the Operation Status Register Event Register when a COND_CLEAR occurs in the Operation Status Register Condition Register. After :STATus:PRESet, the register is set to all 0's.

STAT:OPER:NTR?

STATus:OPERation:NTRansition? This query returns a 16-bit decimal-weighted number and is the contents of the Operation Status Register Negative Transition Register. After STATus:PRESet the register is set to all 0's.

STAT:OPER:PTR

STATus:OPERation:PTRansition *<nrf>* Command sets the Operation Status Register Positive Transition Register, where *<nrf>* is a 16-bit decimal-weighted number. Setting a bit causes a 1 to be written to the corresponding bit in the Operation Status Register Event Register when a COND_SET occurs in the Operation Status Register Condition Register. After :STATus:PRESet, the register is set to all 1's (which as a 16-bit signed integer will read -1).

STAT:OPER:PTR?

STATus:OPERation:PTRansition? This query returns a 16-bit decimal-weighted number and is the contents of the Operation Status Register Positive Transition Register. After STATus:PRESet the register is set to all 1's (which as a 16-bit signed integer will read -1).

STAT:QUES[:EVEN]?

STATus:QUESTionable[:EVENT]? Query to read the Questionable Status Register Event Register. Reading this will clear its contents to 0. The query returns a 16-bit decimal-weighted integer. After *CLS, the Questionable Status Register Questionable Status Register Event Register will be cleared to 0. *RST has no effect.

STAT:QUES:COND?

STATus:QUESTionable:CONDition? Query to read the Questionable Status Register Condition Register. Reading this register is non-destructive. The query returns a 16-bit decimal-weighted integer. The following table indicates the bits used by the Power Meter.

Bit No.	Decimal Weight	Meaning
0-2	-	Not used
3	8	Summary of POWER
4-7	-	Not used
8	256	Summary of CALibration
9-13	-	Not used
14	16384	Unexpected parameter bit
15	-	Bit 15 always 0

The following table contains information about the conditions in the Power Meter which cause the bits to be set (COND_SET) or cleared (COND_CLEAR).

Bit No.	Meaning	EVENTs Causing/ Bit Changes
3	Summary of Power	<p>COND_SET: When error -230, "Data corrupt or Stale" is generated (caused by trying to :FETC? after the Power Meter has been re- initiated but not triggered.)</p> <p>If -231, "Data Questionable; <comment>" error is generated, where:</p> <p><comment> = PLEASE ZERO <comment> = MEASUREMENT ERROR <comment> = NEW SENSOR, ZERO & CAL <comment> = INPUT OVRLOAD <comment> = UP RANGE</p> <p>If error -241, "Hardware error;NO SENSOR" is generated.</p> <p>COND_CLEAR: When no errors are detected by the Power Meter during a measurement covering the causes given for COND_SET. (Note that NEW SENSOR causes a COND_SET followed by the COND_CLEAR).</p>
8	Summary of Calibration	<p>COND_SET: When zeroing or calibration fails after executing CAL:ZERO:AUTO ONCE or CAL:AUTO ONCE or CAL[:ALL] or CAL[:ALL]? Failure is indicated by -231, "Data Questionable; <comment>", where:</p> <p><comment> = ZERO ERROR <comment> = CAL ERROR <comment> = ZERO ERROR,RECORDER OFFSET <comment> = CAL ERROR,RECORDER GAIN</p> <p>COND_CLEAR: When any of the four commands listed above succeed and no errors are placed on the error queue.</p>
14	Unexpected Parameter	<p>COND_SET: If a command is issued to the Power Meter which has a parameter that was not expected. Normally the command will not be executed. However, if unexpected parameter(s) are issued in CONFIGure or MEASure?, the parameter(s) will be ignored and the command will be executed.</p> <p>COND_CLEAR: If a command has the correct parameters with no extra unexpected parameters.</p>

STAT:QUES:ENAB

STATus:QUEStionable:ENABle *<nrf>* Command to set the Questionable Status Register Enable Register. The value *<nrf>* is a 16-bit decimal-weighted integer. Setting a bit causes a 1 to be written to the summary bit 7 of the Status Register when the transition filters are initialised and a COND_SET and/or COND_CLEAR occurs in the corresponding bit. At STATus:PRESet the register is set to all 0's.

STAT:QUES:ENAB?

STATus:QUEStionable:ENABle? This query returns a 16-bit decimal-weighted number and is the contents of the Questionable Status Register Enable Register. After STATus:PRESet the register is set to all 0's.

STAT:QUES:NTR

STATus:QUEStionable:NTRansition *<nrf>* Command sets the Negative Transition Register, where *<nrf>* is a 16-bit decimal-weighted number. Setting a bit causes a 1 to be written to the corresponding bit in the Questionable Status Register Event Register when a COND_CLEAR occurs in the Questionable Status Register Condition Register. After :STATus:PRESet, the register is set to all 0's.

STAT:QUES:NTR?

STATus:QUEStionable:NTRansition? This query returns a 16-bit decimal-weighted number and is the contents of the Questionable Status Register Negative Transition Register. After STATus:PRESet the register is set to all 0's.

STAT:QUES:PTR

STATus:QUEStionable:PTRansition *<nrf>* Command sets the Positive Transition Register, where *<nrf>* is a 16-bit decimal-weighted number. Setting a bit causes a 1 to be written to the corresponding bit in the Questionable Status Register Event Register when a COND_SET occurs in the Questionable Status Register Condition Register. After :STATus:PRESet, the register is set to all 1's (which as a 16-bit signed integer will read -1).

STAT:QUES:PTR?

STATus:QUEStionable:PTRansition? This query returns a 16-bit decimal-weighted number and is the contents of the Questionable Status Register Positive Transition Register. After STATus:PRESet the register is set to all 1's (which as a 16-bit signed integer will read -1).

STAT:PRES

STATus:PRESet The following table defines the effect of the STATus:PRESet command

Table 4-1.

Register	All bits preset to
STAT:OPER:ENAB	0
STAT:OPER:PTR	1
STAT:OPER:NTR	0
STAT:QUES:ENAB	0
STAT:QUES:PTR	1
STAT:QUES:NTR	0

The command has no effect on any registers not listed in the above table.

SYSTEM

The **SYSTEM** command subsystem is used to return error numbers and messages from the Power Meter and to preset the Power Meter.

Subsystem Syntax

SYSTEM
:ERRor?
:PRESet
:VERSion?

SYST:ERR?

The **SYSTem:ERRor?** command returns error numbers and messages from the Power Meter's error queue.

Comments

- When an error is generated by the Power Meter, it stores an error number and corresponding message in the error queue.
- One error is removed from the error queue each time the **SYSTem:ERRor?** command is executed. The errors are cleared in a first-in, first-out order. This means that if several errors are waiting in the error queue, each **SYSTem:ERRor?** query returns the oldest, not the newest error. That error is then removed from the queue.
- When the error queue is empty, subsequent **SYSTem:ERRor** queries return +0, "No error". To clear all errors from the queue, execute the ***CLS** command.
- The error queue has a maximum capacity of 30 errors. If the queue overflows, the last error is replaced with -350, "Too many errors". No additional errors are accepted by the queue until space becomes available.
- ***RST Condition:** the error queue is unaffected.

Example

To read the error queue

SYST:ERR?
enter statement

Query the Power Meter
Enter the error into the computer

SYST:PRES

The **SYSTem:PRESet** command is used to preset the Power Meter. The command is equivalent to the *RST command. See Table 4-2 for information about the *RST configuration.

Numeric values expressed in scientific notation (of the form +D.DDDDE+XX) have units of Watts, unless stated otherwise.

Table 4-2. *RST and SYSTEM:PRESet Conditions

QUERY	SETTING	COMMENTS
:AVER:COUN:AUTO?	4	Auto-filtering selected
:AVER:COUN?	undefined	Return current filter setting
:AVER:STAT?	not affected	Averaging is always ON
:AVER:TCON?	REP	Averaging is REPeat
:AVER:TYPE?	not affected	Average is always SCALAr mean
:CAL:AUTO?	0	No automatic calibration
:CAL:CFAC?	100	Cal. factor is 100%
:CAL:CSET:INT?	not affected	Data Table INT. always ON
:CAL:CSET:SEL?	not affected	Returns currently selected table
:CAL:CSET:STAT?	0	Single correction system enabled
:CAL:RCF?	100	Ref. Cal. factor is 100%
:CAL:ZERO:AUTO?	0	No automatic zeroing
:CALC:CLIM:FAIL?	0	Composite limit summary is pass
:CALC:CLIM:FLIM[:DATA]?	+9.9100E+37	NAN returned, no failures
:CALC:CLIM:FLIM:POIN?	0	No failed limits
:CALC:LIM:CLE:AUTO	0	Do not clear limit data at INIT
:CALC:LIM:FAIL?	0	No failures
:CALC:LIM:INT	0	Limit point interpolation OFF
:CALC:LIM:LOW[:DATA]?	+1.0000E-12	Lower limit set to -90 dBm
:CALC:LIM:LOW:POIN?	1	Always 1 lower limit point
:CALC:LIM:LOW:STAT?	1	Lower limit checking ON
:CALC:LIM:REP[:DATA]?	+9.9100E+37	NAN returned, no failures
:CALC:LIM:REP:POIN?	0	No limit points failed
:CALC:LIM:FCO?	0	Limit failure count is zero
:CALC:LIM:STAT?	0	Limits checking is OFF
:CALC:LIM:UPP[:DATA]?	+1.0000E+06	Upper Limit set to 90 dBm
:CALC:LIM:UPP:POIN?	1	Always 1 upper limit point
:CALC:LIM:UPP:STAT?	1	Upper limit checking ON

Table 4-2. *RST and SYSTem:PRESet Conditions (continued)

QUERY	SETTING	COMMENTS
:INIT:CONT?	0	Power Meter in IDLE state
:INP:STAT?	1	Relay switch is set to SENS PATH
:MEM:CAT?	not affected	Returns currently defined tables
:MEM:PROT?	1	Data Tables cannot be DELETED
:OUTP:ROSC?	0	50 MHz reference is OFF
:POW:RANG:AUTO?	1	Auto-ranging selected
:POW:RANG:LOW?	center range	Return range lower end
:POW:RANG:UPP?	center range	Return range upper end
:POW:REF:STAT?	0	Relative measurement is OFF
:POW:REF?	+1.0000E-03	Measurement relative to 0 dB
:POW:RES?	(0.1% of range)	Resolution of 0.01 dB
[:SENS]:CORR:DCYC:STAT?	0	Duty cycle correction OFF
[:SENS]:CORR:DCYC?	+1.0000E+02	Duty cycle factor is 100%
[:SENS]:CORR:GAIN:STAT?	0	GAIN correction is OFF
[:SENS]:CORR:GAIN?	+0.0000E+00 dB	GAIN correction is 0dB
[:SENS]:CORR:LOSS:STAT?	0	LOSS is OFF (coupled to GAIN)
[:SENS]:CORR:LOSS?	+0.0000E+00 dB	LOSS is 0dB (coupled to GAIN)
[:SENS]:CORR:STAT?	0	Global Corrections are OFF
[:SENS]:FREQ?	+5.0000E+07	Frequency setting is 50 MHz
[:SENS]:FUNC?	not affected	Function is always "POW:AC"
:TRIG:DEL:AUTO?	1	Analog settling delay after trigger
:TRIG:SOUR?	IMM	Trigger source is IMMEDIATE
:UNIT:POW?	W	Units are Watts

SYST:VERS?

SYSTem:VERsion returns the SCPI version in the form XXXX.Y, where XXXX is the year and Y is the version number.

TRIGger

The **TRIGger** command subsystem controls the behaviour of the trigger system. The subsystem can control:

- The source of the trigger (TRIGger:SOURce).
- The insertion of a delay after the trigger is received (TRIGger:DELaY).
- An immediate trigger (TRIGger:IMMediate).

Subsystem Syntax

TRIGger
 [:IMMediate]
 :SOURce <source>
 :SOURce?
 :DELaY
 :AUTO <mode>
 :AUTO?

TRIG[:IMM]

TRIGger[:IMMediate] causes a trigger to occur immediately providing the Power Meter is in the wait-for-trigger state (see the INITiate subsystem). The TRIGger:SOURce must be BUS or HOLD.

Comments

- When the TRIG:IMM command is executed, the measurement result is stored in the Power Meter's memory. Use FETCh? to place the measurement result in the output buffer.
- The TRIGger:SOURce BUS or TRIGger:SOURce HOLD commands remain in effect after the TRIGger:IMMediate command is executed.
- If the Power Meter is not in the wait-for-trigger state, then TRIGger:IMMediate causes error -211, "Trigger ignored".
- If the Power Meter is in the idle state (INIT:CONT is OFF), then TRIGger:IMMediate causes error -211, "Trigger ignored".

Example

To send an immediate trigger

<pre>CONF:POW:AC DEF,0.1DB,DEF TRIG:SOUR BUS INIT</pre>	<p><i>Configure the Power Meter</i> <i>Set trigger source to BUS</i> <i>Place the Power Meter in</i> <i>wait-for-trigger state; store the</i> <i>measurement result in memory when</i> <i>the trigger is received</i></p>
<pre>TRIG:IMM FETC?</pre>	<p><i>Trigger the Power Meter immediately</i> <i>Place the measurement result in the</i> <i>output buffer</i></p>
<pre>enter statement</pre>	<p><i>Enter the result into the computer</i></p>

Related Commands

FETCh?
INITiate

TRIG:SOUR

TRIGger:SOURce <source> configures the trigger system to respond to the specified source. The following trigger sources are available:

- **BUS** Group Execute Trigger <GET> bus command or *TRG common command.
- **HOLD** suspend triggering. The only way to trigger the Power Meter is to use the TRIGger:IMMediate command.
- **IMMediate** the trigger system is always true (continuous triggering).

Parameters

Parameter Name	Parameter Type	Range of Values	Default Units
<i>source</i>	discrete	BUS HOLD IMMediate	none

Comments

- The TRIGger:SOURce command only selects the trigger source, use the INITiate command to place the Power Meter in the wait-for-trigger state. (The MEASure and CONFigure commands automatically execute an INITiate command).
- TRIGger:IMMediate causes a trigger to occur immediately provided the Power Meter is placed in the wait-for-trigger state using INITiate or INIT:CONT ON.
- When TRIGger:SOURce BUS is selected, ABORt returns the Power Meter to the idle state. When a <GET> bus command or a *TRG common command is executed, error –211, “Trigger ignored” occurs.
- When TRIGger:SOURce HOLD or BUS is selected, ABORt returns the Power Meter to the idle state. All subsequent triggers sent are ignored and error –211, “Trigger ignored”, occurs.
- The MEASure and CONFigure commands automatically set the trigger source to IMMediate.
- The READ? command should not be used if the trigger source is TRIGger:SOURce BUS or TRIGger:SOURce HOLD.
- ***RST Condition:** the trigger source is set to TRIGger:SOURce IMMediate.

TRIGger Subsystem

Example To set the trigger source to bus

```
CONF:POW AC DEF,0.1dB,DEF Configure the Power Meter
TRIG:SOUR BUS Set the trigger source to bus
INIT Place the Power Meter in
wait-for-trigger state; store the
measurement result in memory when
the trigger is received
*TRG Trigger the Power Meter
FETC? Place the measurement result in the
output buffer
enter statement Enter the result into the computer
```

Related Commands ABORt
 INITiate

TRIG:SOUR? TRIGger:SOURce? returns the current trigger *source*. The Power Meter returns:

- IMM if TRIGger:SOURce is IMMEDIATE.
- BUS if TRIGger:SOURce is BUS
- HOLD if TRIGger:SOURce is HOLD

Example To query the trigger source

```
TRIG:SOUR BUS Set the trigger source to BUS
TRIG:SOUR? Query the Power Meter to return
trigger source setting
enter statement Enter the result into the computer
```

TRIG:DEL:AUTO TRIGger:DElay:AUTO <mode> is used to set the Power Meter to insert a delay before making a measurement, after a trigger is received or to make a measurement immediately a trigger is received.

Parameters

Parameter Name	Parameter Type	Range of Values	Default Units
mode	boolean	OFF 0 ON 1	none

- Comments**
- If TRIGger:DELAy:AUTO is set to ON|1, the Power Meter will insert a delay between receiving a trigger and making the measurement. The delay is automatically set by the Power Meter and depends on the current range, resolution and filter setting. The delay ensures that the analog circuitry in the Power Meter has settled.
 - If TRIGger:DELAy:AUTO is set to OFF|0, the Power Meter makes the measurement immediately a trigger is received.
 - ***RST Condition:** TRIGger:DELAy:AUTO is set to ON.

Example To make a power measurement with auto delay

CONF:POW AC DEF,0.1dB,DEF	<i>Configure the Power Meter</i>
TRIG:SOUR BUS	<i>Set the trigger source to bus</i>
INIT	<i>Place the Power Meter in wait-for-trigger state; store the measurement result in memory when the trigger is received</i>
TRIG:DELAY:AUTO ON	<i>Enable auto delay</i>
*TRG	<i>Trigger the Power Meter</i>
FETC?	<i>Place the measurement result in the output buffer</i>
enter statement	<i>Enter the result into the computer</i>

TRIG:DEL:AUTO?

TRIGger:DELAy:AUTO? enters 1 or 0 into the output buffer. 1 means that auto delay is enabled, 0 means that auto delay is disabled.

Unit

The **Unit** command subsystem is used to set the Power Meter measurement units to Watts (linear) or dBm (logarithmic).

Subsystem Syntax

UNIT
:POWer <DEF|W|DBM>
:POWer?

UNIT:POW

UNIT:POWer <DEF|W|DBM> is used to set the Power Meter measurement units.

Comments

- UNIT:POW DEF will set the measurement units to Watts.
- UNIT:POW DBM will set the measurement results in dBm (logarithmic power).
- UNIT:POW W will set the measurement results in Watts (linear power).
- For any command with a power numeric value, if the power suffix is omitted, the Power Meter will assume the units set by UNIT:POW.
- The Power Meter will accept numeric values with any valid suffix multiplier, for example pW or uW. Refer to IEEE 488.2, Section 7.7.3.
- If UNIT:POW is set to DBM, the Power Meter will accept power numeric values specified in Watts, where a power parameter is required. Similarly if UNIT:POW is set to W, the Power Meter will accept numeric values in DBM.
- For relative power measurements (POW:REF:STAT ON), if UNIT:POW is W, measurement units are percentage.
- For relative power measurements (POW:REF:STAT ON), if UNIT:POW is DBM, measurement units are dB relative.
- ***RST Condition:** UNIT:POW is set to W (Watts).

Example

To set the measurement units to Watts
UNIT:POW W *Set the measurement units to watts*

UNIT:POW?

UNIT:POWer <DEF|OPTIONAL> returns the current measurement units setting. If DEF is specified, the Power Meter returns W.

IEEE 448.2 Common Command Reference

This section contains information about the IEEE 448.2 Common (*) commands that the Power Meter executes. Table 4-3 contains information about the commands.

Table 4-3. IEEE 448.2 Command Reference

Category	Command	Purpose
General	*IDN?	Identification Query
	*RST	Resets the Power Meter (see SYST:PRES)
	*OPT?	Option Query ¹
Synchronization	*OPC	Operation Complete
	*OPC?	Operation Complete Query
	*WAI	Wait-to-continue command
Instrument State	*SAV	Save Power Meter configuration (see Chapter 3)
	*RCL	Recall Power Meter configuration (see Chapter 3)
Power Meter Status	*CLS	Clear all Status Registers
	*ESE	Standard Event Status Enable
	*ESE?	Standard Event Status Enable query
	*ESR?	Event Status Register query
	*SRE	Service Request Enable
	*SRE?	Service Request Enable Query
	*STB?	Read Status Byte query
Trigger	*TRG	Trigger Command (see TRIGger)

¹ The *OPT? command returns “1,1,1” when a Power Sensor is connected and “1,0,1” when no Power Sensor is connected.

Configuring the Power Meter

About This Chapter

This chapter contains information about preparing the Power Meter for use. The main sections of the chapter are:

- General Information 5-1
- Setting the Power Meter's Address 5-3
- Mating Connectors 5-4
- Internal Battery 5-4

General Information

This section contains information about initial inspection, how to check that the Power Meter is operating within specification and what to do if the Power Meter needs servicing. It also contains notes and cautions to prevent you causing damage to the Power Meter or the mainframe.

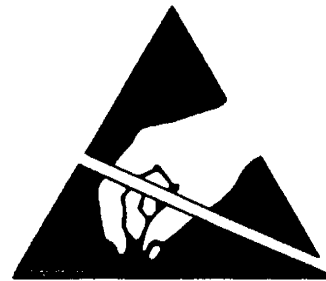

ATTENTION Static Sensitive Devices

Caution



1. The Power Meter contains static sensitive devices. To prevent causing damage to the Power Meter, it is extremely important that you observe strict anti-static precautions when you handle or service the Power Meter. In particular, do not touch the connector pins on the interface connectors or the SENSOR input.
2. The Power Meter is shipped with an ESD protection cap placed over the SENSOR input. It is recommended that you retain the cap and place it over the SENSOR input when a sensor cable is not connected.

3. Always switch off the VXI mainframe before installing or removing a VXI card. Failure to do this could result in damage to the card or the mainframe.
-

Initial Inspection

When you receive your Power Meter, the package should contain the following items:

- The Power Meter.
 - A power sensor cable - 1.5 meters, 5 feet long. (See Note 1)
 - A User's Manual. (See Note 2)
 - A Service Manual. (See Note 3)
-

Note



1. Option 004 deletes the standard length power sensor cable. To complete the Power Meter, you need to order one of the power sensor cables listed in Table 5-1.

Table 5-1. Power Meter Sensor Cables

Model	Length
IIP 11730A	1.5 meters (5 feet)
HP 11730B	3.0 meters (10 feet)
HP 11730C	6.1 meters (20 feet)
HP 11730D	15.2 meters (50 feet)
IIP 11730E	30.5 meters (100 feet)
IIP 11730F	61.0 meters (200 feet)

2. Option 916 adds an additional copy of the User's Manual.
 3. A Service Manual is only provided if Option 915 is ordered. The Service Manual can be ordered as a separate item using HP part number E1416-90002.
-

Inspect the shipping container for damage. If the shipping container or cushioning material is damaged, it should be kept until the contents of the shipment have been checked for completeness and the Power Meter has been checked mechanically and electrically. Procedures for completely checking electrical performance are given in Appendix B. If the contents are incomplete, if there is mechanical damage or defect, or if the Power Meter does not pass the electrical performance test, notify the nearest Hewlett-Packard office. If the shipping container is damaged, or the cushioning material shows signs of stress, notify the carrier as well as the Hewlett-Packard office. Keep the shipping materials for the carrier's inspection.

Specifications

Power Meter specifications are provided in Appendix A. These specifications are performance standards or limits against which the Power Meter may be tested. Supplemental characteristics are also listed in Appendix A. Supplemental characteristics are not warranted specifications, but are provided to give you additional information about the performance of the Power Meter. Performance tests for checking that the Power Meter meets its specifications are provided in Appendix B.

In Case of Trouble

If the Power Meter requires calibration or servicing, contact your nearest Hewlett-Packard office. A list of Hewlett-Packard offices is given at the back of this manual.

Setting the Power Meter's Address

This section tells you how to set the Power Meter's logical address switch.

The Logical Address Switch

Figure 5-1 shows the location and factory default setting of the Power Meter's logical address switch.

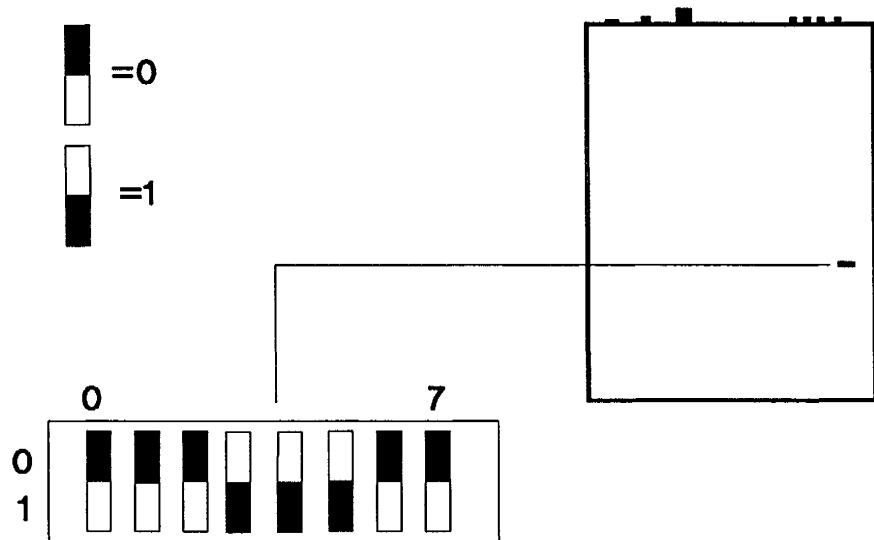

Figure 5-1. Power Meter Logical Address Switch Settings

The factory default setting for the logical address switch is 56 decimal. This is equivalent to a secondary HP-IB address of 07. (To calculate the secondary address you divide the logical address by eight). If you have more than one Power Meter, you must change the address to some other multiple of 8 (e.g. 8, 16, 24, 32 decimal), as there can only be one instrument per secondary address. For more

information about addressing, refer to the *Series C Installation and Getting Started Guide*.

Mating Connectors

This section contains information about the Power Meter front-panel connectors.

Recorder Output

The Recorder Output requires a 50 Ω BNC male mating connector that is compatible with the specifications of US MIL-C-39012.

Power Ref

The Power Ref output requires a 50 Ω N-type male mating connector that is compatible with the specifications of US MIL-C-39012.

Sensor

Use any HP 11770 series sensor cable to connect to any HP 8480 series Power Sensor or the HP 11722 Sensor Mount.

Internal Battery

The Power Meter contains a lithium battery. Read the following warning.

Warning



This product uses a lithium battery which may explode if mishandled. Do Not recharge or disassemble the battery, and do not dispose of it by burning. Check your local country regulatory requirements for the disposal of lithium batteries. When the battery needs replaced, use only the battery listed in the Service Manual.

Safety

WARNING If this instrument is not used as specified, the protection provided by the equipment could be impaired. This instrument must be used in a normal condition only (in which all means for protection are intact).

Operating Environment

This instrument is designed for Indoor use only.

The module may be operated at temperatures from 0°C to 55°C at altitudes up to 4600 m (15,000 ft.). The module may be operated in environments up to 95% relative humidity to 40°C, but it should be protected from temperature extremes which may cause condensation.

To ensure adequate cooling do not obstruct air vents in the instrument cabinet.

CAUTION This instrument is designed for use in Installation Category II and Pollution Degree 2 per IEC 1010 and 644 respectively.

Cleaning

To clean the module/instrument: Use a soft, clean damp cloth to clean the front-panel and side covers.

Noise Declaration

LpA<70dB

am Arbeitsplatz (operator position)
normaler Betrieb (normal position)
nach DIN 45635 pt.19 (per ISO 7779)

Specifications

This appendix contains the specifications and characteristics that apply to the Power Meter.

Specifications vs. Characteristics

Specifications

Specifications describe warranted performance over the temperature range of 0°C to +55°C after one hour of continuous operation (unless otherwise noted).

Characteristics

Characteristics provide useful information by giving functional, but non-warranted performance parameters.

Table A-1. Specifications

Electrical Characteristics	Performance Limits	Conditions
Frequency Range	100 kHz to 50 GHz	Sensor dependent
Power Range	-70 to +44 dBm (100 pW to 25W)	Sensor dependent
Dynamic Range	50 dB total range	In 10 dB steps
Result Units	Watts or dBm Percent or dB	Absolute measurement mode Relative measurement mode
Resolution Low Mid High	1.0% full scale (0.1 dB) 0.1% full scale (0.01 dB) 0.01% full scale (0.001 dB)	
Accuracy Instrumentation Zero Set (digital settability of zero)	Absolute Measurement Mode ± 0.02 dB or ± 0.5% Relative Measurement Mode ± 0.02 dB or ± 0.5% ± 0.04 dB or ± 1% ± 0.5% of full scale ± 2% of full scale	Within calibration range Outside calibration range Most sensitive range. Divide percentage by a factor of 10 for each higher range, ± 1 count. If using the HP 8484A, 8481D, 8485D, 8486D, or 8487D Power Sensors.
Power reference Accuracy	1.00 mW ± 1.2% ± 0.9%	Internal 50 MHz oscillator factory set to ± 0.7% traceable to U.S. National Institute of Standards and Technology. Worst case RSS for one year

Table A-2. Characteristics

Meter Noise

Meter noise is specified as a percent of full scale, at two standard deviations from the mean. The noise was measured over a one minute interval, under constant temperature, and in the lowest range. Decrease noise by a factor of 10 for each higher range, for all sensors and all filters except those noted.

HP 8481A/B/H, 8482A/B/H, 8483A, 8485A, R/Q/W8486A, 8487A Sensors:

Number of Averages	Noise (%)
1	12
2	6
4	2.4
8	1.8
16	0.9
32	0.7
64	0.5
128	0.4
256	0.3
512	0.2
1024	0.15

HP 8484A, 8481D, 8485D, and 8487D Sensors: multiply noise levels by four for all filters

HP R/Q8486D Sensors: multiply noise levels by six for all filters

Zero Drift of sensors

As a percent of full scale after one hour at a constant temperature and a 24-hour warm up. Divide percentage by a factor of ten for each higher range.

HP 8481A ,8482A, 8483A, 8485A, 8486A, and 8487A Sensors: <0.3% of full scale in the lowest range.

HP 8484A, 8481D, 8485D, 8486D, and 8487D Sensors: <2.0% of full scale on lowest range.

Power Reference SWR

1.05 Maximum at 50 MHz, 50Ω

Recorder Output

0—1 volt analog without digital filtering or calibration factor. 1 kΩ output impedance.

Additional Information

Environmental

Operating Temperature: 0° to +55°C after one hour of continuous use.

Storage Temperature: -40° to +70°C.

Humidity: Up to 95% Relative Humidity +25° to +40°C.

EMC: Meets EN55011 and EN50082-1.

Physical

Size: Single slot, C-size.

Weight: 1.6 kg/3.5 lb (nominal).

Dimensions (height x width x length): 262 mm x 30 mm x 355 mm (nominal).

WARNING

For continued protection against fire hazard, replace the line fuse only with the same type and line rating (type nA/nV). The use of other fuses or materials is prohibited.

Cooling Requirements

For 10°C rise: 1.0mm H₂O at 0.2 litres/sec

Power Requirements

Total Power dissipation is 10 VA

Maximum current drawn from dc voltage rails:

dc Volts	dc Current	Dynamic Current
+5 V	1.0 A	0.1 A
+24 V	0.1 A	0.01 A
-24 V	0.1 A	0.01 A

The fuses used in this module are listed below, and are non-operator replaceable Axial Leaded, Very Fast Blow fuses.

Fuse	Current	Voltage	Type
F1	3A	125V	FF3AL
F2	3A	125V	FF3AL

Remote Operation

Message-based device

Compatibility

VXI Word Serial Rev 1.3

Performance Tests

This appendix provides tests to confirm that the Power Meter meets the specifications listed in Appendix A. The Performance Tests can be divided into 3 parts:

- Functional Verification
- Operational Verification
- Performance Test

Note



The Power Meter requires periodic verification of operation. Under normal operating conditions you should test the Power Meter at least once a year. To verify Power Meter operation and calibration completely, you should carry out the Performance Tests.

Functional Verification

The Functional Verification consists of two tests:

1. Power-up Test
2. Analog Functional Test

Performing the Functional Verification provides a high degree of confidence that the Power Meter is able to make measurements.

Operational Verification

The Operational Verification consists of the following tests:

1. Functional Verification
2. Zero Carry-over Test
3. Instrument Accuracy Test

Performing the Operational Verification provides >90% confidence that the Power Meter meets the specifications listed in Appendix A.

Performance Tests

The Performance Tests consist of the following tests:

1. Functional Verification
2. Operational Verification
3. Power Reference Level Test

Performing the Performance Tests ensures that the Power Meter meets the specifications listed in Appendix A.

Note



If the Performance Tests are to be considered valid, the following conditions must be met.

- a. The Power Meter and test equipment must have one hour warm up time before performing steps 2 and 3.
 - b. The ambient temperature must be 0° to +55° C.
-

Equipment Required

The equipment and accessories required to maintain the Power Meter is listed in Table B-1. Other equipment may be substituted if it meets or exceeds the critical specifications listed.

Table B-1. Recommended Test Equipment

Instrument	Critical Specifications	Recommended Model
Digital Voltmeter	Range 0 to 20 Vdc	HP 3456A
Frequency Counter	Range: 10 Hz to 50 MHz Resolution: 1 Hz	HP 5328B Option 031
VXI Bus Mainframe		HP E1400B
Power Meter	Range: 1 mW Transfer Accuracy: 0.2% (Input to output)	HP 432A
Range Calibrator	Calibration uncertainty $\pm 0.25\%$	HP 11683A ^{1,2}
Thermistor Mount	SWR: 1.05 at 50 MHz Accuracy: ± 0.5 at 50 MHz	HP 478A-H76 ³
Command Module		HP E1405A

¹ HP 11683A Range Calibrators with a serial prefix below 3042A may produce inconsistent results on the most sensitive ranges. Range Calibrators below this serial prefix can be modified. Contact your nearest HP Service Office for more information about the modification.

² For the Operational Verification, only the Range Calibrator is required.

³ HP standards lab calibration to $\pm 0.58\%$ at 50 MHz (traceable to National Institute of Standards and Technology).

Program Notes

The Programs required to perform the tests are located at the end of this appendix. Read the following notes before you use the programs.

1. The lines in the example programs which are preceded by !, are comment lines which have been included for program explanation and to increase program clarity. These lines are not necessary for correct operation of the programs and can be omitted.
2. The TMSL commands in the example programs are shown in their long form. The upper case letters denote the abbreviated form of the command. Use the abbreviated form for shorter program lines. For better program readability, use the long form. Refer to *Section 4 - Command Reference* for more information about TMSL command syntax.
3. The ? at the end of a command denotes a query command. This causes the Power Meter to output data when the command is completed.

Power-up Test

Before running the Power-up test sequence, a Power Sensor and Sensor Cable should be connected to the Power Meter input, otherwise a "Hardware Missing" error will occur during the test. The sensor should not be connected to any power source.

When the VXI Mainframe is switched ON, a series of automatic tests are run on the VXI Interface and the Power Meter Digital control circuitry. At initiation of this test, the red 'Failed' annunciator will come ON briefly, before going OFF, followed by indications from the other annunciators that will be dependant upon the Power Meter state and configuration. The Power Meter will be configured in the same state it was in when last switched OFF.

On successful completion of the test there should be no annunciator ON on the front panel.

Failure of the Power Up Test sequence will be indicated by one or more of front panel annunciators being ON at completion of the test. The following table will assist in determining the likely cause of failure.

Table B-2. Power-up Troubleshooting

Annunciator	Likely Cause	Troubleshooting
Failed	Communication Problem between Command Module and Power Meter	Command Module failure and/or hardware fault in the Power Meter
Access	Communication Problem between Command Module and Power Meter	See Command Module Manual
Error	Programming or Configuration	Read error messages and take appropriate action
Power Ref	Indicates if Power Ref is ON or OFF	Switch OFF with OUTP:ROSC OFF command

Analogue Functional Check

This functional test, checks the Power Meter's ability to make a power measurement. The 1 mW, 50 MHz Reference Output is used as a signal source.

A Power Sensor and Sensor Cable is used to connect the Reference Power output to the Power Meter input. Successful completion of the test will give a high level of confidence that the analog measurement circuits are operational.

To perform the test, enter and run the program *VXL_FUNC* listed at the end of this appendix.

Zero Carryover Test

Specification

Electrical Characteristics	Performance Limits	Conditions
Accuracy: Zero set (Digital settability of zero)	$\pm 0.5\%$ full scale	Most sensitive range. Decrease percentage by factor of 10 for each higher range ± 1 count.

Description After the HP E1416A is initially zeroed, the change in the readings is monitored as the HP E1416A is stepped through its ranges. This test also checks drift and noise since drift, noise, and zero carryover readings cannot be separated.

Equipment

VXI Mainframe	HP E1400B
Range Calibrator	HP 11683A
Power Sensor Cable	HP 11730A
Command Module	HP E1405A

Procedure

1. Connect the equipment as shown in Figure B-1, and switch on all the equipment.

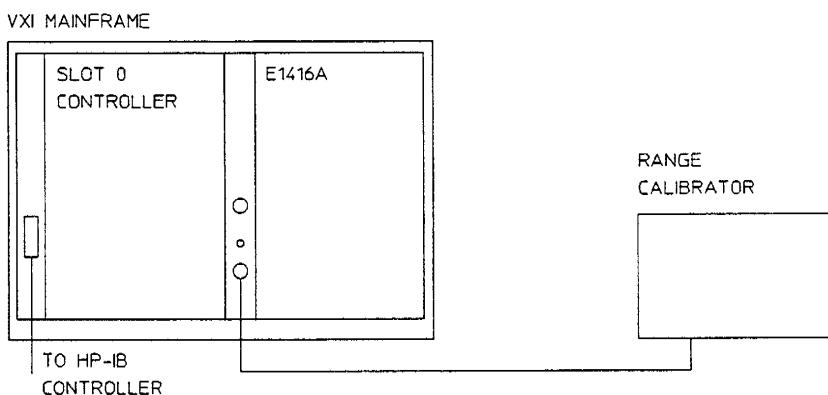

Figure B-1. Zero Carryover Test Setup

2. Enter and run the program *VXI_ZERO* listed at the end of this appendix. Follow the instructions contained in the program.

HP E1416A Decade Range	Min	Actual Results	Max
1	-0.05 μ W	-----	0.05 μ W
2	-0.1 μ W	-----	0.1 μ W
3	-0.001 mW	-----	0.001 mW
4	-0.01 mW	-----	0.01 mW
5	-0.1 mW	-----	0.1 mW

Instrument Accuracy Test

Specification

Electrical Characteristics	Performance Limits	Conditions
Accuracy: Instrumentation, includes sensor linearity. ¹ $\pm 0.5\%$ or ± 0.02 dB	Within same calibration range	

¹When operating at the upper end of the Power Sensor power range, add the appropriate sensor power linearity percentage.

Description

The HP E1416A is initially calibrated with the Range Calibrator set to 1 mW. The readout is then monitored as the range calibrator is switched to provide reference inputs corresponding to each of the HP E1416A operating ranges.

Equipment

VXI Mainframe	HP E1400B
Range Calibrator	HP 11683A
Power Sensor Cable	HP 11730A
Command Module	HP E1405A

Procedure

1. Connect all equipment as shown in Figure B-2 and switch on the equipment.

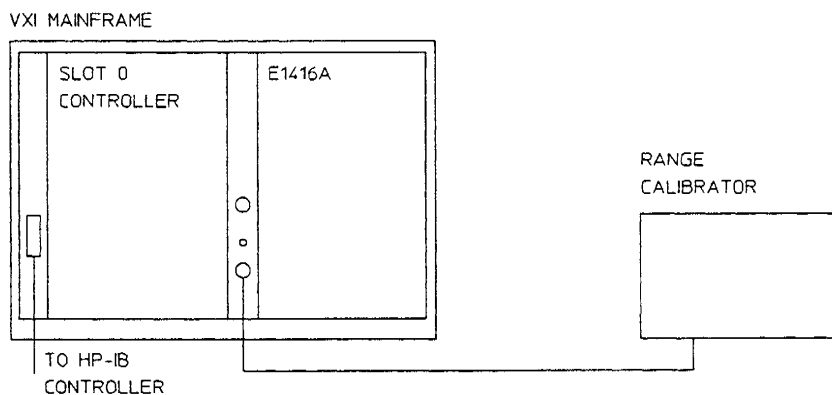

Figure B-2. Instrument Accuracy Test Setup

2. Enter and run program *VXLACCU* listed at the end of this appendix. Follow the instructions contained in the program.

Range Calibrator Setting	Min	Actual Results	Max
3 μ W	3.10 μ W	-----	3.23 μ W
10 μ W	9.90 μ W	-----	10.10 μ W
30 μ W	31.4 μ W	-----	31.8 μ W
100 μ W	99.5 μ W	-----	100.5 μ W
300 μ W	.314 mW	-----	.318 mW
1 mW	0.995 mW	-----	1.005 mW
3 mW	3.14 mW	-----	3.18 mW
10 mW	9.95 mW	-----	10.05 mW
30 mW	31.4 mW	-----	31.8 mW
100 mW	99.5 mW	-----	100.5 mW

Note



It is not necessary to check instrument accuracy in dBm. The HP E1416A uses the same internal circuitry to measure power and mathematically converts watts to dBm.

Power Reference Level Test

Specification

Electrical Characteristics	Performance Limits	Conditions
Power reference Accuracy	$\pm 1.2\%$ $\pm 0.9\%$	Worst case. Root Sum of Squares for one year.
Power reference	1.0 mW	Internal 50 MHz oscillator factory set to $\pm 0.7\%$ traceable to National Institute of Standards and Technology

Description

The power reference oscillator output is factory adjusted to 1 mW $\pm 0.7\%$. To achieve this accuracy, Hewlett-Packard employs a special measurement system accurate to 0.5% (traceable to the National Institute of Standards and Technology) and allows for a transfer error of $\pm 0.2\%$ in making the adjustment. If an equivalent measurement system is employed for verification, the power reference oscillator output can be verified to 1 mW $\pm 1.9\%$ ($\pm 1.2\%$ accuracy plus $\pm 0.5\%$ verification system error plus $\pm 0.2\%$ transfer error = 1.9% maximum error).

The power reference oscillator can be set to $\pm 0.7\%$ using the same equipment and following the adjustment procedure. To ensure maximum accuracy in verifying the power reference oscillator output, the following procedure provides step by step instructions for using specified Hewlett-Packard test instruments of known capability. If equivalent test instruments are used, signal acquisition criteria may vary and reference should be made to the manufacturer's guidelines for operating the instruments.

Note



The HP E1416A may be returned to the nearest Hewlett-Packard office to have the power reference oscillator checked and/or adjusted.

Equipment	VXI Mainframe	HP E1400B
	Test Power Meter	HP 432A
	Thermistor Mount	HP 478A-H76
	Digital Voltmeter (DVM)	HP 3456A
	Command Module	HP E1405A

- Procedure**
1. Set the DVM to measure resistance. Connect the DVM between the Vrf connector on the rear panel of the HP 432A power meter, and pin 1 on the thermistor mount end of the HP 432A power meter interconnect cable. Refer to Figure B-3.

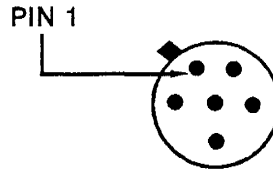

Figure B-3. Pin 1 on Thermistor Mount

2. Round off the DVM indication to two decimal places and record this value as the internal bridge resistance (R) of the HP 432A power meter (approximately 200Ω).

R_____

3. Connect the HP 432A power meter to the HP E1416A as shown in Figure B-4 and switch on all the equipment.

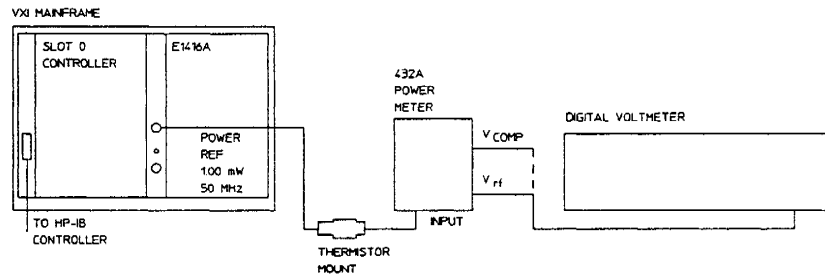

Figure B-4. Power Reference Level Test Setup

Note



Wait thirty minutes for the HP 432A power meter thermistor mount to stabilize before proceeding to the next step.

4. Set the HP 432A power meter RANGE switch to Coarse Zero. Adjust the front panel Coarse Zero control to obtain a zero meter indication.
5. Fine zero the HP 432A power meter on the most sensitive range, then set the RANGE switch to 1 mW.

Note



Ensure that the DVM input leads are isolated from chassis ground when performing the next step.

6. Set the DVM to measure microvolts. Connect the positive and negative input leads, respectively, to the Vcomp and Vrf connectors on the rear panel of the HP 432A power meter.
7. Observe the reading on the DVM. If less than 400 microvolts, proceed to the next step. If 400 microvolts or greater, press and hold the HP 432A power meter Fine Zero switch and adjust the Coarse Zero control so that the DVM indicates 200 microvolts or less. Release the Fine Zero switch and proceed to the next step.
8. Round the DVM reading to the nearest microvolt. Record this reading as V0.

V0-----

9. Send the following command to the Power Meter:

OUTPUT ADDR;"OUTP:ROSC ON"

Check that the green POW REF annunciator goes on.

10. Observe the reading on the DVM. Record the reading as V1.

V1-----

11. Disconnect the DVM negative input lead from the Vrf connector on the HP 432A power meter. Reconnect it to the HP 432A power meter chassis ground.
12. Observe the DVM reading. Record the reading as Vcomp.

Vcomp-----

13. Calculate the power reference oscillator output level (Prf) from the following formula:

$$Prf = \frac{2V_{comp}(V_1 - V_0) + (V_0^2 - V_1^2)}{4R(CalibrationFactor)}$$

Where:

Prf=power reference oscillator output level

Vcomp=previously recorded value

V1=previously recorded value

V0=previously recorded value

Calibration Factor=value for thermistor mount at 50 MHz
(traceable to the National Institute of Standards and
Technology).

14. Verify that Prf is within the limits shown in the following table.
Record the reading.

Min	Actual	Max
0.988 mW	-----	1.012 mW

VXI_FUNC

```
10  ! HP E1416A ANALOGUE FUNCTIONAL CHECK
20  ! Filename "VXI_FUNC"
30  ! 30 JULY 1990 1000
40  ! *****
50  DIM A$[30],Sys_err$[30],Title$[80]
60  Title$="*** Functional Verification of the HP E1416A VXI Power Meter ***"
70  PRINTER IS 1
80  CLEAR SCREEN ! *** CLEAR THE SCREEN ***
90  PRINT TABXY(6,4),Title$
100 INPUT "*** ENTER THE POWER METER ADDRESS (TYPICAL 70907) ***",Addr
110 WAIT 2
120 !
130 PRINT TABXY(6,10),"Connect the power sensor to the POWER REF OUTPUT"
140 WAIT 1
150 DISP "WHEN READY ..... PRESS ANY KEY TO CONTINUE"
160 ON KBD ALL GOTO Return ! WAITING FOR KEYPRESS
170 GOTO 170
180 !
190 Return: OFF KBD
200 !
210 CLEAR Addr
220 ! Set the Power Meter to a known state
230 OUTPUT Addr;"*RST"
240 CLEAR SCREEN
250 PRINT TABXY(6,4),Title$
260 ! Set the Reference Calibration Factor for Sensor
270 INPUT "ENTER THE SENSOR REFERENCE CALIBRATION FACTOR ...",Set_calf
280 !
290 OUTPUT Addr;":CALibration:RCF";Set_calf;"PCT"
300 !Zero and Calibrate the Power Meter
310 OUTPUT Addr;":CALibration:ALL?"
320 !
330 CLEAR SCREEN !
340 PRINT
350 PRINT
360 PRINT " ZEROING AND CALIBRATING THE POWER METER"
370 PRINT
380 PRINT TABXY(12,8),"(...this routine will take approx 30 seconds)"
390 !
400 DISP " . . . Please Wait . ."
410 ! Check to see what the outcome was.
420 ENTER Addr;Cal_result
430 IF Cal_result=0 THEN
440 ! Calibration cycle was successful
450 !
460 ! Now set the measurement calibration factor
461 CLEAR SCREEN
462 !
470 INPUT " ENTER THE SENSOR MEASUREMENT CALIBRATION FACTOR ....",Set_mecf
480 OUTPUT Addr;":CALibration:CFAC";Set_mecf
490 !
500 ! Now switch on the Reference Oscillator
510 OUTPUT Addr;":OUTPut:ROSCillator:STATe ON"
520 !
530 ! Let the Power Meter and Power Sensor settle.
540 PRINT
550 PRINT
560 PRINT "WAITING FOR THE POWER METER AND POWER SENSOR TO SETTLE"
570 PRINT
580 WAIT 3
590 ! OK, ready to make a measurement (use *RST settings)
600 OUTPUT Addr;":MEASure:POWer:AC?"
610 !
```

```

620     ! .. and get the result
630     PRINT
640     PRINT
650     PRINT "MAKING THE MEASUREMENT"
660     WAIT 3
670     CLEAR SCREEN !
680     ENTER Addr;Reading
690     !
700     PRINT TABXY(10,5),"*** Reference Oscillator Measures ";Reading*1000;"mW ***"
710     !
720     ELSE
730     GOSUB Read_error
740     GOSUB Sort_error
750     DISP "Press "&CHR$(129)&" RUN "&CHR$(128)&" to restart program"
760     GOTO Finished
770     END IF
780     !
790     PRINT TABXY(10,10),"*** Functional Verification Test Completed ***"
800     GOTO Finished
810     !
820 Read_error:!
830     OUTPUT Addr;":SYST:ERR?"
840     ENTER Addr;Sys_err$
850     RETURN
860     !
870 Sort_error:!
880     PRINT TABXY(6,10),"AN ERROR HAS OCCURRED DURING CALIBRATION: PLEASE TAKE APPROPRIATE ACTION"
890     PRINT TABXY(12,14),"Error list follows....."
900     PRINT
910     !
920     LOOP
930     PRINT TABXY(20,0),Sys_err$
940     GOSUB Read_error
950     WAIT 2
960     EXIT IF Sys_err$[1,2]="+0"
970     END LOOP
980     RETURN
990     !
1000 Finished:    !
1010     END

```

VXI_ZERO

```
10  ! ZERO_CARRYOVER TEST
20  ! FILENAME "VXI_ZERO"
30  ! 14th August 1990 1600
40  !*****
50  OPTION BASE 1
60  PRINTER IS 1
70  DIM Range(1:5),Reading(1:5),Rdg(1:5),Min_spec(1:5)
80  DIM Max_spec(1:5),Sys_err$[30],A$[30]
90  !
100 DATA -.00000005,-.0000001,-.000001,-.00001,-.0001
110 READ Min_spec(*)
120 DATA .00000005,.0000001,.000001,.00001,.0001
130 READ Max_spec(*)
140 DATA -20,-10,0,10,20
150 READ Range(*)
160 !
170 Zero_header:IMAGE 4X,"| RANGE | MIN | RESULT | MAX |PASS/FAIL |"
180 Print_data:IMAGE 4X,A,5X,D,4X,A,X,M.3D,X,2A,X,A,X,S.3D,X,2A,X,A,X,S.3D,X,2A,X,A,3X,4A,3X,A
190 !
200 CLEAR SCREEN
210 INPUT "ENTER THE POWER METER ADDRESS (TYPICAL 70907) ...",Addr
220 !
230 PRINT " Hewlett-Packard E1416A Power Meter Zero Carryover Test"
240 PRINT
250 PRINT "CONNECT THE EQUIPMENT AS SHOWN IN FIG B-1"
260 PRINT
270 PRINT "SET UP THE RANGE CALIBRATOR AS FOLLOWS ....."
280 PRINT
290 PRINT "FUNCTION SWITCH ..... STANDBY"
300 PRINT "RANGE SWITCH ..... 3 uW"
310 PRINT "POLARITY ..... NORMAL"
320 PRINT "POWER ..... ON"
330 !
340 GOSUB Wait
350 !
360 Preset: !
370 CLEAR SCREEN
380 DISP "PRESETTING THE POWER METER ... PLEASE WAIT"
390 OUTPUT Addr;"*RST"
400 WAIT 4
410 !
420 CLEAR SCREEN
430 PRINT TABXY(20,12),"PRESET COMPLETED"
440 WAIT 3
450 !
460 Zero_count=0
470 Zeroing: !
480 CLEAR SCREEN
490 Zero_count=Zero_count+1
500 IF Zero_count>3 THEN
510 PRINT TABXY(20,12),"Unable to Zero after 3 attempts"
520 GOTO Finished
530 END IF
540 CLEAR SCREEN
550 PRINT
560 PRINT
570 PRINT " ZEROING THE POWER METER"
580 PRINT
590 PRINT TABXY(12,8),"(... this routine will take approx 30 seconds)"
600 !
610 DISP " . . . . Please Wait . . ."
620 !
630 ! CHECKING FOR OPERATION COMPLETE
```



```

640 OUTPUT Addr;":CAL:ZERO:AUTO ONCE;*OPC?"
650 ENTER Addr;Complete$
660 ! CHECKING FOR ERRORS AND GOOD ZERO
670 GOSUB Read_error
680 IF Sys_err$[1,2]="+0" THEN
690     WAIT 4
700     OUTPUT Addr;":READ?"
710     ENTER Addr;Result
720     CLEAR SCREEN
730     PRINT TABXY(20,12),"ZERO READING IS ... ";Result
740     WAIT 3
750     IF ABS(Result)>3.E-8 THEN GOTO Zeroing
760 ELSE
770     PRINT TABXY(20,12),"THERE IS AN ERROR : PLEASE TAKE APPROPRIATE ACTION ....."
780     PRINT TABXY(20,14),"Error list follows ....."
790     PRINT
800     LOOP
810         PRINT TABXY(20,0),Sys_err$
820         GOSUB Read_error
830         WAIT 2
840     EXIT IF Sys_err$[1,2]="+0"
850     END LOOP
860 Stop:DISP "PRESS ' RUN ' TO RESTART PROGRAM"
870     GOTO Finished
880     !
890 END IF
900 Zero_prt: !
910 CLEAR SCREEN
920 PRINT TABXY(20,12),"ZEROING OPERATION COMPLETED"
930 WAIT 4
940 !
950 CLEAR SCREEN
960 PRINT " Making Measurement for Zero Carryover Test"
970 PRINT
980 GOSUB Header
990 FOR I=1 TO 5
1000     OUTPUT Addr;":POW:RANG:UPP ";Range(I);"DBM"
1010     WAIT 2
1020     OUTPUT Addr;":READ?"
1030     ENTER Addr;Reading(I)
1040     GOSUB Convert
1050     GOSUB Print
1060 NEXT I
1070 PRINT " ";RPT$("-",56)
1080 DISP "WHEN READY ..... PRESS ANY KEY TO OBTAIN HARD COPY"
1090 ON KBD ALL GOTO Printout
1100 GOTO 1100
1110 !
1120 Printout: !
1130 OFF KBD
1140 PRINTER IS 26
1150 PRINT " HEWLETT PACKARD E1416A VXI POWER METER ZERO CARRYOVER TEST"
1160 PRINT
1170 GOSUB Header
1180 FOR I=1 TO 5
1190     GOSUB Convert
1200     GOSUB Print
1210 NEXT I
1220 PRINT " ";RPT$("-",56)
1230 PRINTER IS 1
1240 CLEAR SCREEN
1250 !
1260 PRINT TABXY(20,12),"ZERO CARRYOVER TEST COMPLETED"
1270 !
1280 GOTO Finished
1290 !

```

```

1300 Wait:      !
1310 DISP "WHEN READY ..... PRESS ANY KEY TO CONTINUE"
1320 ON KBD ALL GOTO Return
1330 GOTO 1330
1340 Return:OFF KBD
1350 RETURN
1360           !
1370 Print:     !
1380 IF Reading(I)>Min_spec(I) AND Reading(I)<Max_spec(I) THEN
1390   Result$="PASS"
1400 ELSE
1410   Result$="FAIL"
1420 END IF
1430 Unit$="uW"
1440 Min=Min_spec(I)*1.E+6
1450 Max=Max_spec(I)*1.E+6
1460 IF Range(I)>-10 THEN
1470   Unit$="mW"
1480   Min=Min_spec(I)*1.E+3
1490   Max=Max_spec(I)*1.E+3
1500 END IF
1510 PRINT USING Print_data;"|",I,"|",Min,Unit$,"|",Rdg(I),Unit2$,"|",Max,Unit$,"|",Result$,"|"
1520 RETURN
1530           !
1540 Read_error: !
1550 OUTPUT Addr;":SYST:ERR?"
1560 ENTER Addr;Sys_err$
1570 RETURN
1580           !
1590 Header:     !
1600 PRINT "      ";RPT$("-",56)
1610 PRINT USING Zero_header
1620 PRINT "      |";RPT$("-----|",5)
1630 RETURN
1640           !
1650 Convert:   !
1660           ! CONVERT READING TO uW
1670 Rdg(I)=Reading(I)*1.E+6
1680 Unit2$="uW"
1690           ! CONVERT READING TO mW
1700 IF ABS(Rdg(I))>=.999 THEN
1710   Rdg(I)=Rdg(I)/1000
1720   Unit2$="mW"
1730 END IF
1740 RETURN
1750           !
1760 Finished: !
1770 END

```

VXI_ACCU Part 1

```
10 ! INSTRUMENT ACCURACY TEST
20 ! FILENAME "VXI_ACCU"
30 ! 15 August 1990 1500
40 !*****
50 OPTION BASE 1
60 PRINTER IS 1
70 DIM Rge(1:10),Clb(1:10),Read(1:10),Mi_sp(1:10),Ma_sp(1:10)
80 DIM St_rg(1:10),Sy_e$(30),A$(30)
90 DATA -20,-20,-10,-10,0,0,+10,+10,+20,+20
100 READ Rge(*)
110 DATA 3,10,30,100,300,1,3,10,30,100
120 READ Clb(*)
130 DATA 3.10,9.90,31.4,99.5,.314,.995,3.14,9.95,31.4,99.5
140 READ Mi_sp(*)
150 DATA 3.23,10.10,31.8,100.5,.318,1.005,3.18,10.05,31.8,100.5
160 READ Ma_sp(*)
170 DATA 3,10,30,100,300,1,3,10,30,100
180 READ St_rg(*)
190 !
200 Accuracy_header:IMAGE X,"| CAL OUTPUT | MIN | RESULT | MAX | PASS/FAIL |"
210 Print_data:IMAGE X,A,3X,3D,X,2A,3X,3(A,4D.3D,X,3A),A,4X,4A,4X,A
220 !
230 CLEAR SCREEN
240 INPUT "ENTER THE POWER METER ADDRESS (TYPICAL 70907) . . . .",Addr
250 GOSUB Read_error
260 !
270 PRINT "Hewlett-Packard E1416A VXI Power Meter Instrument Accuracy Test"
280 PRINT
290 PRINT "CONNECT THE EQUIPMENT AS SHOWN IN FIGURE B-2"
300 PRINT
310 PRINT
320 PRINT TABXY(10,10),"SET UP THE RANGE CALIBRATOR AS FOLLOWS. . . ."
330 PRINT
340 PRINT " FUNCTION SWITCH . . . . . STANDBY"
350 PRINT " RANGE SWITCH . . . . . 3 uW"
360 PRINT " POLARITY . . . . . NORMAL"
370 PRINT
380 GOSUB Hold
390 !
400 Reset: !
410 CLEAR SCREEN
420 DISP "PRESETTING THE POWER METER . . . . PLEASE WAIT"
430 OUTPUT Addr;"*RST"
440 WAIT 4
450 !
460 CLEAR SCREEN
470 PRINT TABXY(20,12),"PRESET COMPLETED"
480 WAIT 3
490 !
500 Zero_count=0
510 Zeroing: !
520 CLEAR SCREEN
530 Zero_count=Zero_count+1
540 IF Zero_count>3 THEN
550 PRINT TABXY(20,12),"Unable to Zero after 3 attempts"
560 GOTO Finished
570 END IF
580 CLEAR SCREEN
590 PRINT
600 PRINT
610 PRINT " ZEROING THE POWER METER . . . ."
620 PRINT
630 PRINT TABXY(12,8),"(. . . this routine will take approx 30 seconds)"
```

```
640 !
650 DISP " . . . . Please Wait . . "
660 ! CHECKING FOR OPERATION COMPLETE
670 OUTPUT Addr;":CAL:ZERO:AUTO ONCE;*OPC?"
680 ENTER Addr;Complete$
690 ! CHECKING FOR ERRORS AND GOOD ZERO
700 GOSUB Read_error
710 IF Sy_e$[1,2]="+0" THEN
720     WAIT 4
730     GOSUB Read_pwr
740     PRINT TABXY(20,12),"ZERO READING IS . . . . ";A$
750     WAIT 3
760     Result=VAL(A$)
770     IF ABS(Result)>5.E-8 THEN GOTO Zeroing
780 ELSE
790     GOSUB Sort_error
800 END IF
```

VXI_ACCU Part 2

```
810      !
820 Zero_prt:  !
830      CLEAR SCREEN
840      PRINT TABXY(20,12),"ZEROING OPERATION COMPLETED ....."
850      WAIT 4
860      !
870      ! CAL ROUTINE *****
880      CLEAR SCREEN
890      PRINT
900      PRINT TABXY(10,10)," SET UP THE RANGE CALIBRATOR AS FOLLOWS"
910      PRINT " FUNCTION SWITCH..... CALIBRATE"
920      PRINT " RANGE SWITCH ..... 1 mW"
930      Cal_count=0
940      GOSUB Hold
950      !
960 Cal:      !
970      CLEAR SCREEN
980      Cal_count=Cal_count+1
990      IF Cal_count>3 THEN
1000     PRINT TABXY(20,12),"Unable to CAL after 3 attempts"
1010     GOTO Finished
1020     END IF
1030     DISP " CALIBRATING THE POWER METER ..... PLEASE WAIT"
1040     OUTPUT Addr;":CAL:CFAC 100"
1050     OUTPUT Addr;":CLS;:CAL:AUTO ONCE;*OPC?"
1060     WAIT 4
1070     ENTER Addr;Complete$
1080     GOSUB Read_error
1090     IF Sy_e$[1,2]="+0" THEN
1100       GOSUB Read_pwr
1110       PRINT TABXY(20,12),"***POWER METER READS. ";VAL(A$)*1000;"mW ***"
1120       Result=VAL(A$)
1130       WAIT 3
1140       IF ABS(Result)>>1.001E-3 OR ABS(Result)<9.99E-4 THEN GOTO Cal
1150       ELSE
1160         GOSUB Sort_error
1170       END IF
1180       WAIT 2
1190       !
1200 Cal_prt:  !
1210     CLEAR SCREEN
1220     PRINT TABXY(20,12),"CALIBRATION DONE"
1230     !
1240     WAIT 3
1250     ! TAKE MEASUREMENTS.
1260     CLEAR SCREEN
1270     PRINT "Making Measurements for the Instrument Accuracy Test"
1280     PRINT
1290     GOSUB Header
1300     !
1310     I=0
1320     LOOP
1330       I=I+1
1340       GOSUB Set_unit
1350     EXIT IF I>10
1360     PRINT TABXY(1,25),RPT$(" ",78)
1370     PRINT TABXY(1,25),"SET THE CALIBRATOR RANGE TO.. ";St_rg(I);Unit3$
1380     GOSUB Hold
1390     !
1400 Power:    !
1410     OUTPUT Addr;":POW:RANG:UPP ";Rge(I);"DBM"
1420     WAIT 1
1430     OUTPUT Addr;":READ?"
```

```

1440 ENTER Addr;Read(I)
1450 GOSUB Convert
1460 GOSUB Compare
1470 PRINT TABXY(0,I+4)
1480 PRINT USING Print_data;"|",Clb(I),Unit3$,"|",Mi_sp(I),Unit2$,
"|",Rdg(I),Unit$,"|",Ma_sp(I),Unit2$,"|",Result$,"|"
1490 END LOOP
1500 PRINT " ";RPT$("-",66)
1510 PRINT TABXY(1,25),RPT$(" " ,78)
1520 DISP "WHEN READY ... PRESS ANY KEY TO OBTAIN HARD COPY"
1530 ON KBD ALL GOTO Printout ! WAITING FOR KEYPRESS
1540 GOTO 1540
1550 !
1560 Printout: !
1570 OFF KBD
1580 PRINTER IS 26
1590 PRINT "HP E1416A VII POWER METER INSTRUMENT ACCURACY TEST"
1600 PRINT
1610 GOSUB Header
1620 FOR I=1 TO 10
1630 GOSUB Set_unit
1640 GOSUB Convert
1650 GOSUB Compare
1660 PRINT USING Print_data;"|",Clb(I),Unit3$,"|",Mi_sp(I),Unit2$,
"|",Rdg(I),Unit$,"|",Ma_sp(I),Unit2$,"|",Result$,"|"
1670 NEXT I
1680 PRINT " ";RPT$("-",66)
1690 PRINTER IS 1
1700 CLEAR SCREEN
1710 PRINT TABXY(20,12),"INSTRUMENT ACCURACY TEST COMPLETED"
1720 GOTO Finished
1730 !
1740 Read_pwr: !
1750 WAIT 4
1760 OUTPUT Addr;":READ?"
1770 ENTER Addr;A$
1780 RETURN
1790 !
1800 Read_error: !
1810 OUTPUT Addr;":SYST:ERR?"
1820 ENTER Addr;Sy_e$
1830 RETURN
1840 !
1850 Set_unit: !
1860 Unit2$="uW"
1870 Unit3$="mW"
1880 IF I>4 THEN Unit2$="mW"
1890 IF I>5 THEN Unit3$="mW"
1900 RETURN
1910 !
1920 Header: !
1930 PRINT " ";RPT$("-",66)
1940 PRINT USING Accuracy_header
1950 PRINT " |";RPT$("-----|",5)
1960 RETURN
1970 !
1980 Hold: !
1990 DISP "WHEN READY ... PRESS ANY KEY TO CONTINUE"
2000 ON KBD ALL GOTO Return ! WAITING FOR KEYPRESS
2010 GOTO 2010
2020 Return:OFF KBD
2030 RETURN
2040 !
2050 Sort_error: !
2060 PRINT TABXY(20,12),"THERE IS AN ERROR : PLEASE TAKE APPROPRIATE ACTION"
2070 PRINT

```

```

2080 PRINT TABXY(20,14),"Error list follows ....."
2090 PRINT
2100 LOOP
2110 PRINT TABXY(20,0),Sy_e$
2120 GOSUB Read_error
2130 WAIT 2
2140 EXIT IF Sy_e$[1,2]="+0"
2150 END LOOP
2160 !
2170 Stop:DISP "PRESS "&CHR$(129)&" RUN "&CHR$(128)&" to restart program"
2180 GOTO Finished
2190 RETURN
2200 !
2210 Convert: !
2220 ! CONVERT READING TO microwatt
2230 IF Read(I)<=3.E-4 THEN
2240 Rdg(I)=Read(I)*1.E+6
2250 Unit$="uW"
2260 ELSE
2270 ! CONVERT READING TO milliwatt
2280 Rdg(I)=Read(I)*1000
2290 Unit$="mW"
2300 END IF
2310 RETURN
2320 !
2330 Compare: !
2340 IF Rdg(I)>Mi_sp(I) AND Rdg(I)<Ma_sp(I) THEN
2350 Result$="PASS"
2360 ELSE
2370 Result$="FAIL"
2380 END IF
2390 RETURN
2400 !
2410 Finished: !
2420 END

```

Hewlett-Packard Company

Tested by _____

Model HP E1416A

VXI Power Meter

Serial Number _____

Date _____

Performance Test Record

	Min	Actual Result	Max
ZERO CARRYOVER			
HP E1416A Decade Range			
1	-0.05 μ W	-----	0.05 μ W
2	-0.1 μ W	-----	0.1 μ W
3	-0.001 mW	-----	0.001 mW
4	-0.01 mW	-----	0.01 mW
5	-0.1 mW	-----	0.1 mW
INSTRUMENT ACCURACY			
Accuracy	3.10 μ W	-----	3.23 μ W
3 μ W	3.10 μ W	-----	3.23 μ W
10 μ W	9.90 μ W	-----	10.10 μ W
30 μ W	31.4 μ W	-----	31.8 μ W
100 μ W	99.5 μ W	-----	100.5 μ W
300 μ W	.314 mW	-----	.318 mW
1 mW	0.995 mW	-----	1.005 mW
3 mW	3.14 mW	-----	3.18 mW
10 mW	9.95 mW	-----	10.05 mW
30 mW	31.4 mW	-----	31.8 mW
100 mW	99.5 mW	-----	100.5 mW
POWER REFERENCE			
Prf	0.988 mW	-----	1.012 mW

If Something Goes Wrong

In the unlikely event something goes wrong, refer to the *HP E1416A Service Manual*. It is most important that basic checks for the Power Meter are completed before calling Hewlett-Packard or returning the Power Meter. This should avoid unnecessary repair work and waiting time. If the problem is still unresolved after some simple checks, call your nearest Hewlett-Packard Sales and Support Office, as listed in Table B-3.

Table B-3. Hewlett-Packard Sales and Service Offices

<p>IN THE UNITED STATES California Hewlett-Packard Co. 1421 South Manhattan Ave. P.O. Box 4230 Fullerton, CA 92631 (714) 999-6700</p>	<p>IN AUSTRALIA Hewlett-Packard Australia Ltd. 31-41 Joseph Street Blackburn, Victoria 3130 895-2895</p>	<p>IN JAPAN Yokogawa-Hewlett-Packard Ltd. 29-21 Takaido-Higashi, 3 Chome Suginami-ku Tokyo 168 (03) 331-6111</p>
<p>Hewlett-Packard Co. 301 E. Evelyn Mountain View, CA 94039 (415) 694-2000</p>	<p>IN CANADA Hewlett-Packard (Canada) Ltd. 17500 South Service Road Trans-Canada Highway Kirkland, Quebec H9J 2X8 (514) 697-4232</p>	<p>IN PEOPLE'S REPUBLIC OF CHINA China Hewlett-Packard, Ltd. P.O. Box 9610, Beijing 4th Floor, 2nd Watch Factory Main Bldg. Shuang Yu Shu, Bei San Huan Rd. Beijing, PRC 256-6888</p>
<p>Colorado Hewlett-Packard Co. 24 Inverness Place, East Englewood, CO 80112 (303) 649-5000</p>	<p>IN FRANCE Hewlett-Packard France F-91947 Les Ulis Cedex Orsay (6) 907-78-25</p>	<p>IN SINGAPORE Hewlett-Packard Singapore Pte. Ltd. 1150 Depot Road Singapore 0410 273 7388 Telex HPSGSO RS34209 Fax (65) 2788990</p>
<p>Georgia Hewlett-Packard Co. 2000 South Park Place P.O. Box 105005 Atlanta, GA 30339 (404) 955-1500</p>	<p>IN GERMAN FEDERAL REPUBLIC Hewlett-Packard GmbH Vertriebszentrale Frankfurt Berner Strasse 117 Postfach 560 140 D-6000 Frankfurt 56 (0611) 50-04-1</p>	<p>IN TAIWAN Hewlett-Packard Taiwan 8th Floor, Hewlett-Packard Building 337 Fu Hsing North Road Taipei (02) 712-0404</p>
<p>Illinois Hewlett-Packard Co. 5201 Tollview Drive Rolling Meadows, IL 60008 (312) 255-9800</p>	<p>IN GREAT BRITAIN Hewlett-Packard Ltd. King Street Lane Winnersh, Wokingham Berkshire RG11 5AR 0734 784774</p>	<p>IN ALL OTHER LOCATIONS Hewlett-Packard Inter-Americas 3495 Deer Creek Rd. Palo Alto, California 94304</p>
<p>New Jersey Hewlett-Packard Co. 120 W. Century Road Paramus, NJ 07653 (201) 265-5000</p>	<p>IN OTHER EUROPEAN COUNTRIES Hewlett-Packard (Schweiz) AG Allmend 2 CH-8967 Widen (Zurich) (0041) 57 31 21 11</p>	
<p>Texas Hewlett-Packard Co. 930 E. Campbell Rd. Richardson, TX 75081 (214) 231-6101</p>		

Error Messages

Using This Appendix

This appendix contains information about the Power Meter's error messages. It explains how to read the Power Meter's error queue, discusses the types of command language-related error messages, and provides a table of all of the Power Meter's error messages and their probable causes.

Overview

Error reporting in the Power Meter complies with the model given in IEEE 488.2 and consists of an error queue which, in the Power Meter, can hold 30 different error messages. These error messages are reported to the error queue by the power meter when conditions arise that are abnormal. These messages vary from simple warnings to flagging unusual or erroneous operating conditions.

When errors are placed onto the error queue, the Power Meter front panel Error annunciator will illuminate. This annunciator will remain on until you read or clear the error(s). It is important that you take some action when this annunciator is illuminated, since the errors may require action to be taken to ensure integrity of power measurements. The normal method of

How To Read Errors

You read the the error(s) contained in the error queue using the `:SYSTem:ERRor?` command. This reads the oldest error message in the queue first. The format of the response to `:SYST:ERR?` is shown in Figure C-1.

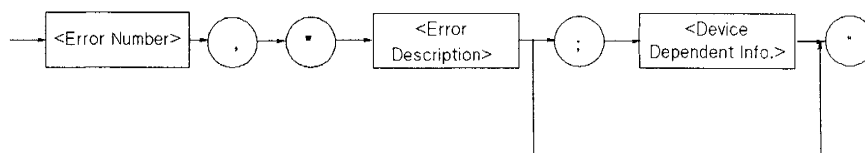

Figure C-1. Error Message Format

Within the Power Meter there is an instrument error register. This register contains an integer in the range $[-32768, 32767]$. Negative error numbers are reserved by the TMSL standard whereas positive numbers are instrument dependent. (The Power Meter's errors all fall into the negative number range.) The error number is the value of the instrument's error register. The error description is a short description of the error, (optionally) followed by further information

about the error. The device dependent information part of the error response may contain information which will allow the user to determine the exact error and context. For example,

-222,“Data out of range;CFAC 1-150%”

The message “Data out of range” is qualified by the device dependent part which will help you identify that an incorrect calibration factor was sent (CAL:CFAC n). If there has been no error, that is, if the error queue is empty, the Power Meter should respond with +0,“No error”.

It has been indicated that, when errors are detected, they are placed in an error queue. This operates in a first in, first out basis. If the error queue overflows, the last error in the queue is replaced with error -350,“Too many errors”. Any time the queue overflows, the least recent errors remain in the queue, and the most recent error is discarded. Reading an error from the head of the queue removes that error from the queue, and opens a position at the tail of the queue for a new error, if one is subsequently detected. When all errors have been read from the queue, further error queries shall return +0,“No error” and the front panel Error annunciator will extinguish. The error queue does not hold duplicate messages, that is, at any instant of time, there will not be an error message repeated more than once.

In some modes of operation, however, the Power Meter will keep attempting to place the same error message on the error queue. If the condition causing this error is not rectified, and you query the error queue, the Power Meter will place another message of the same type. An example of this type of operation is when the Power Meter is continuously taking measurements (when INIT:CONT ON and TRIG:SOUR IMM) and no sensor is connected to the Power Meter. In this situation, every time the Power Meter takes a power measurement, it attempts to report the error, -241,“Hardware missing;NO SENSOR”. Once this has been read from the error queue, the Power Meter will place the error message on the error queue again, to keep the condition flagged. Once the sensor has been connected, further queries will clear the error queue and the Error annunciator will extinguish. One important point to remember when using the error queue is that it reports a history of unusual conditions. It is therefore possible to read an error from the queue, which may have occurred some time previously and is no longer relevant. Errors can be cleared from the error queue by sending *CLS or reading the last item from the queue.

Error Numbers

The system-defined error numbers are chosen on an enumerated (“1 of N”) basis.

COMMAND errors are numbers in the range [-199,-100] and they indicate that an IEEE 488.2 syntax error has been detected by the instrument’s parser. The occurrence of any error in this class will cause the command error bit (bit 5) in the event status register to be set.

EXECUTION errors are numbers in the range [-299,-200] and they indicate that an error has been detected by the Power Meter’s execution control block. The occurrence of any error in this class should cause the execution error bit (bit 4) in the event status register to be set.

DEVICE SPECIFIC errors are numbers in the range [-399,-300] and they indicate that the Power Meter has detected an error which is not a command error, a query error or an execution error; some device operations did not properly complete, possibly due to an abnormal hardware or firmware condition. The Power Meter’s self-test response error code falls into this range. The occurrence of any error in this class will cause the device-specific bit (bit 3) of the event status register to be set.

Table C-1. Error Messages

Error	Comment
-101, "Invalid character"	Unrecognised character in specified parameter.
-102, "Syntax error"	Command is missing a space or comma between parameters.
-103, "Invalid separator"	Command parameter is separated by a space rather than a comma.
-104, "Data type error"	The wrong data type (i.e. number, character, expression) was used when specifying a parameter
-108, "Parameter not allowed"	Parameter specified in a command which has only a command header.
-109, "Missing parameter"	No parameter specified in the command in which a parameter is required.
-113, "Undefined header"	Command header was incorrectly specified.
-123, "Numeric overflow"	Numeric parameter specified was too large
-124, "Too many digits"	257 digits were specified for a parameter.
-128, "Numeric data not allowed"	A number was specified for a parameter when a letter is required.
-131, "Invalid suffix"	Parameter suffix incorrectly specified (eg. 45 MEGAHERTZ specified instead of 45MHZ)
-138, "Suffix not allowed"	Parameter suffix is specified when one is not allowed.
-141, "Invalid character data"	The parameter type specified is not allowed (eg. TRIG:SOUR EXT - Only HOLD BUS IMM are valid.
-151, "Invalid string data"	A string data element was expected but was invalid. (eg. an END message was received before the terminal quote character.)
-108, "Parameter not allowed;PARAMETER IGNORED"	With CONF:POW:AC or MEAS:POW:AC? <conf_parm>, if the parameter has additional unexpected parameters this error will be generated. Normally, three parameters are expected: <rng>, <res'n>, <freq>. Bit 14 of the Questionable status register is set.
-211, "Trigger ignored"	Indicates that <GET> or *TRG, or TRIG:IMM was received and recognised by the device but was ignored because the Power Meter was not in wait-for-trigger state.

Table C-1. Error Messages (continued)

Error	Comment
-213, "INIT ignored"	Indicates that a request for a measurement initiation was ignored as the Power Meter was already initiated.
-214, "Trigger deadlock"	TRIG:SOUR was set to HOLD or BUS and a READ? or MEASure was attempted, expecting TRIG:SOUR to be set to IMMEDIATE.
-221, "Settings conflict;BAD TABLE DATA"	An attempt was made to transfer a table from EDITING SPACE to MEASUREMENT SPACE using the command :CAL:CSET:SEL <table name>. This failed because either no RCF was specified, or the was not 1-1 correspondence in the frequency, cal-fac. lists, DEFINED for <table name>.
-221, "Settings conflict;MUST :MEM:SEL <table name>"	You attempted to CAL:CSET:SEL but no table had been MEM:SElect so the Power Meter did not know which table to transfer to MEASUREMENT SPACE.
-221, "Settings conflict;MUST SPECIFY FREQUENCY"	A warning to indicate that a frequency must be sent (:FREQ command or by sending a third parameter in the CONF:POW:AC command) so that the Power Meter can find the appropriate calibration factor.
-221, "Settings conflict;NO TABLE DEFINED"	You attempted to MEM:SElect but no table had been MEM:DEFined so the Power Meter did not know which table to edit in EDITING SPACE.
-221, "Settings conflict;NO TABLE SELECTED"	You attempted to CAL:CSET:STAT ON but no table had been CAL:CSET:SElected. The Power Meter returns this error, leaving STAT OFF.
-221, "Settings conflict;TABLE ALREADY DEFINED"	You attempted to MEM:DEFine <table name> but <table name> was already known to the Power Meter. Use another name, or simply re-specify new frequency, cal-factor list or RCF points.
-221, "Settings conflict;TABLES ARE PROTECTED"	You attempted to MEM:DElete having left MEM:PROT:STAT ON. Disable protection and the DElete commands will operate.
-222, "Data out of range;BAD FILTER LENGTH"	Filter length should be a power of two between 1 and 1024.
-222, "Data out of range;BAD POWER VALUE"	You specified invalid value for a range setting. For example -34W.

Table C-1. Error Messages (continued)

Error	Comment
-222, "Data out of range;BAD RANGE SETTING"	You specified a value in the range setting command which was invalid for the sensor being used.
-222, "Data out of range;BAD RESOLUTION SETTING"	You specified an incorrect resolution value.
-222, "Data out of range;CFAC 1-150%"	CAL:CFAC n was sent, but n was out-of-range.
-222, "Data out of range;DCYC 1-100%"	CORR:DCYC n was sent, but n was out-of-range.
-222, "Data out of range;ESE 0-255"	*ESE n was sent, but n was out-of-range.
-222, "Data out of range;FR < 100kHz"	FREQ n was sent but n was too small.
-222, "Data out of range;FR > 999.9GHz"	FREQ n was sent but n was too large.
-222, "Data out of range;GAIN < -99.99dB"	CORR:GAIN n was sent but n was too small.
-222, "Data out of range;GAIN > +99.99dB"	CORR:GAIN n was sent but n was too large.
-222, "Data out of range;LL < -199dBm"	CALC:LIM:LOW n was sent but n was too small.
-222, "Data out of range;LL < 1E-23W"	CALC:LIM:LOW n was sent but n was too small.
-222, "Data out of range;LL > 1E07W"	CALC:LIM:LOW n was sent but n was too large.
-222, "Data out of range;LL > 99dBm"	CALC:LIM:LOW n was sent but n was too large.
-222, "Data out of range;LOSS < -99.99dB"	CORR:LOSS n was sent but n was too small.
-222, "Data out of range;LOSS > +99.99dB"	CORR:LOSS n was sent but n was too large.
-222, "Data out of range;NON-EXISTENT NAME"	MEM:SEL <name> was sent but <name> has not been MEM:DEFined.
-222, "Data out of range;RANGE TOO HIGH"	POW:RANG:UPP/LOW n was sent but n was too large.
-222, "Data out of range;RANGE TOO LOW"	POW:RANG:UPP/LOW n was sent but n was too small.

Table C-1. Error Messages (continued)

Error	Comment
-222, "Data out of range;RCF 50-120%"	CAL:RCF n was sent but n was out-of-range.
-222, "Data out of range;RCL 1-10"	*RCL n was sent but n was out-of-range.
-222, "Data out of range;REF < -199dBm"	POW:REF n was sent but n was too small.
-222, "Data out of range;REF < 1E-20mW"	POW:REF n was sent but n was too small.
-222, "Data out of range;REF > 1E10mW"	POW:REF n was sent but n was too large.
-222, "Data out of range;REF > 99dBm"	POW:REF n was sent but n was too small.
-222, "Data out of range;SAV 1-10"	*RCL n was sent but n was out-of-range.
-222, "Data out of range;SRE 0-255"	*SRE n was sent but n was out-of-range.
-222, "Data out of range;UL < -199dBm"	CALC:LIM:UPP n was sent but n was too small.
-222, "Data out of range;UL < 1E-23W"	CALC:LIM:UPP n was sent but n was too small.
-222, "Data out of range;UL > 1E07W"	CALC:LIM:UPP n was sent but n was too large.
-222, "Data out of range;UL > 99dBm"	CALC:LIM:UPP n was sent but n was too large.
-224, "Illegal parameter value;:FUNC <bad function>"	Only long/short forms of POWer:AC allowed.
-224, "Illegal parameter value;AVER[:STAT] OFF 0"	AVER:STAT cannot be switched OFF
-224, "Illegal parameter value;BAD FUNCTION SETTING"	Function setting string was too long and invalid.
-224, "Illegal parameter value;BAD TABLE NAME"	Table name was incorrectly specified.
-224, "Illegal parameter value;CAL:CSET:INT OFF 0"	Linear interpolation is on for retrieval of the calibration factors using the frequency.

Table C-1. Error Messages (continued)

Error	Comment
-224, "Illegal parameter value;CALC:LIM:INT ON 1"	Linear interpolation is OFF because there is only 1 upper/lower limit point.
-224, "Illegal parameter value;RCF NOT PROGRAMMED"	You must place valid RCF into the SElected table.
-224, "Illegal parameter value;TABLE NOT DEFINED"	You attempted to CAL:CSET:SEL <table name> but <table name> has not been DEFined.
-224, "Illegal parameter value;TOO MANY TABLES"	You attempted to DEFine too many tables. (Maximum number allowed is 10.)
-230, "Data corrupt or stale"	You attempted to FETC? while the power meter was in wait-for-trigger state or after the Power Meter had been *RST (or SYST:PRES).
-231, "Data questionable;CAL ERROR"	Power Meter calibration failed. The most likely cause is attempting to calibrate without applying a 1mW power to the Power Sensor.
-231, "Data questionable;CAL ERROR, RECORDER GAIN"	Power Meter was unable to set the recorder output to 1 volt. Verify that the 1mW source is connected properly during calibration.
-231, "Data questionable;NEW SENSOR, ZERO & CAL"	Power sensor has been changed. You should zero and calibrate the Power Meter to ensure the integrity of the measurements.
-231, "Data questionable;PLEASE CAL"	Power Meter requires calibration.
-231, "Data questionable;ZERO ERROR"	Power Meter zeroing failed. The most likely cause is attempting to zero when some power signal is being applied to the Power Sensor.
-231, "Data questionable;ZERO ERROR, RECORDER OFFSET"	Power Meter was unable to set the recorder output to 0 Volts.
-240, "Hardware error;BAD BATTERY"	Battery voltage failed to maintain the contents of memory.
-241, "Hardware missing;NO SENSOR"	The Power Meter is unable to execute the command because no power sensor is connected.
-314, "Save/recall memory lost;RECALL FAIL"	Memory contents were lost.
-330, "Self-test failed"	A Power Sensor should be connected. If *TST? returns 1 with a Power Sensor connected there is a hardware fault in the Power Meter.
-350, "Too many errors"	The error queue is full as more than 30 errors have occurred (no duplicate errors)